

DAIKIN

PCVAU0737F

Shaping air to your needs

VRV III-S

THE INTELLIGENT AIR CONDITIONING SYSTEM



A special air conditioning system designed for small-sized buildings

Heat Pump 50 Hz

HEAT PUMP

R-410A

The ideal air conditioning small office

Extending the core “5S” concept—Space saving, Sufficient capacity, Slim design, Sound-reduced operation and Single phase power supply—Daikin’s VRVIII-S offers added value with the “1E” concept—Easy installation. With all these features and more, we proudly present the ideal air conditioning system designed for small-sized buildings.



The 5S + 1E concepts of
VRVIII-S

5S
concept

Space saving

Sufficient capacity

Slim design

Sound-reduced operation

Single phase power supply

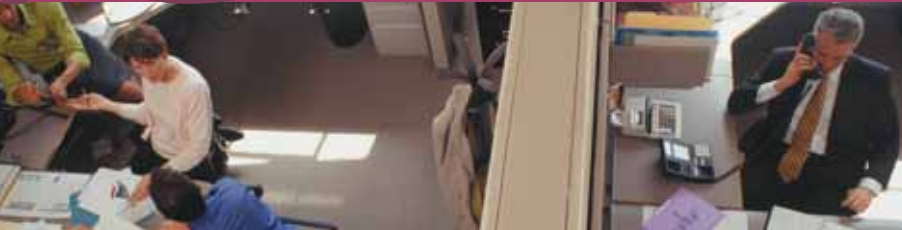

Easy installation

1E
concept

system for S and shops

Slim, compact and sufficient capacity

The VRVIII-S is highly space saving, featuring slim and compact outdoor units. It is suitable for small offices and shops with capacities of 4, 5 and 6 class (11.2, 14 and 15.5 kW).

Volume
Approx. 50%
reduction

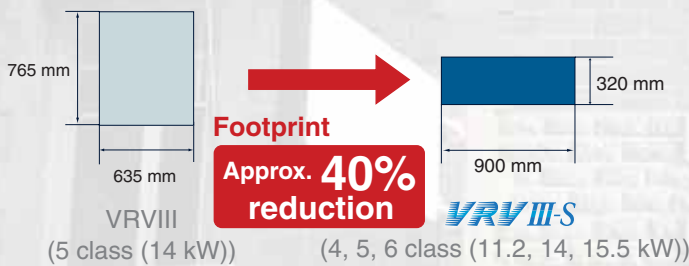

Outdoor unit can be installed on a balcony

The compact, trunk-shaped outdoor unit can easily be installed on a balcony, realising complete system installation within each floor. This enables more useful utilisation of the space on the building rooftop.

Contents

Introduction.....page 1

Main features.....page 3

Control systems.....page 9

Indoor unit lineup.....page 15

Specifications.....page 27

└ Indoor units.....page 27

└ Outdoor units.....page 34

Option list.....page 35

└ Indoor units.....page 35

└ Outdoor units.....page 37

└ Control systems.....page 37

MAIN FEATURES

Wide range of choices

To suit the variety of rooms found in small offices and shops, the VRVIII-S system offers a wide range of indoor and outdoor units.

VRVIII-S indoor and outdoor units are almost as easy to install as residential air conditioning systems, making them ideal for small offices and shops.



Outdoor units

3 models

Outdoor unit can be selected from three models to provide the power that suits your needs. The trunk-shaped outdoor unit can be neatly installed outside the office.

Outdoor unit lineup

Model Name	RXYMQ4PV4A	RXYMQ5PV4A	RXYMQ6PV4A
Capacity Range	4 class (11.2 kW)	5 class (14 kW)	6 class (15.5 kW)
Capacity Index	100	125	140















Indoor units

14 types 78 models

A wide range of indoor units includes 78 models in 14 types. The indoor units can be selected to match rooms and preferences.



Indoor unit lineup 14 types 78 models

Type	Model Name	Capacity Range	20	25	32	40	50	63	80	100	125	140	145
			Capacity Index	2.2 kW	2.8 kW	3.6 kW	4.5 kW	5.6 kW	7.1 kW	9 kW	11.2 kW	14 kW	16 kW
Ceiling Mounted Cassette (Round Flow)	FXFQ-PVE			●	●	●	●	●	●	●	●		
Ceiling Mounted Cassette (Compact Multi Flow)	FXZQ-MVE		●	●	●	●	●						
Ceiling Mounted Cassette (Double Flow)	FXCQ-MVE		●	●	●	●	●	●	●		●		
Ceiling Mounted Cassette Corner	FXKQ-MAVE			●	●	●		●					
Slim Ceiling Mounted Duct	FXDQ-PBVE (700 mm width type)		●	●	●								
	FXDQ-NBVE (900/1,100 mm width type)					●	●	●					
Ceiling Mounted Built-in	FXSYQ-MVE		●	●	●	●	●	●	●	●	●		
Ceiling Concealed (Duct)	FXDYQ-MAV1								●	●	●		●
Ceiling Mounted Duct	FXMQ-PVE		●	●	●	●	●	●	●	●	●	●	
Ceiling Suspended	FXHQ-MAVE				●			●		●			
Wall Mounted	New FXAQ-PVE		New	New	New	New	New	New					
Floor Standing	FXLQ-MAVE		●	●	●	●	●	●					
Concealed Floor Standing	FXNQ-MAVE		●	●	●	●	●	●					

Note: R-410A VRV system indoor units are not compatible with the R-22 VRV system.

Connection unit series indoor units

Type	Model Name	Capacity Range	20	25	32	40	50	71	100	125	
			Capacity Index	2.2 kW	2.8 kW	3.6 kW	4.5 kW	5.6 kW	8 kW	11.2 kW	14 kW
			Capacity Index	20	25	31.25	40	50	71	100	125
Ceiling Suspended Cassette	FXUQ-MAV1								●	●	●
		Connection Unit	—						BEV071MAVE	BEV100MAVE	BEV125MAVE

Note: BEV units are necessary for Connection unit series indoor units. Refer to the Engineering Data Book for details.

Energy efficiency and quiet operation

Outdoor units use Daikin's unique scroll compressor for energy efficiency and quiet operation.

High COP during both cooling and heating operations

One of the top features of the VRVIII-S is its energy efficiency. It achieves high COP during cooling and heating operations by utilising Daikin's unique scroll compressor.

High COP achieved in all ranges!

		VRVII-S Previous model RXYMQ-MV4A	VRVIII-S
Cooling	4 class (11.2 kW)	3.07	3.15
	5 class (14 kW)	2.81	2.94
	6 class (15.5 kW)	2.82	3.03
Heating	4 class (11.2 kW)	3.27	3.37
	5 class (14 kW)	3.58	3.73
	6 class (15.5 kW)	3.45	3.62

Above values are based on the following nominal conditions:

- 2 built-in units are connected (4 class (11.2 kW): FXSYQ50M x 2; 5 class (14 kW): FXSYQ63M x 2; and 6 class (15.5 kW): FXSYQ63M + FXSYQ80M.)
- Cooling: Indoor temp. of 27°CDB, 19.0°CWB, and outdoor temp. of 35.0°CDB.
- Heating: Indoor temp. of 20°CDB, and outdoor temp. of 7°CDB, 6°CWB.

Quiet operation provides luxurious comfort

Quietness is yet another important feature of Daikin's VRVIII-S system. To reduce noise and realise comfortable operation, latest technologies and features are applied to the outdoor units.

1 dB(A) reduced in each model!

		VRVII-S Previous model RXYMQ-MV4A	VRVIII-S
Cooling	4 class (11.2 kW)	51	50
	5 class (14 kW)	52	51
	6 class (15.5 kW)	54	53
Heating	4 class (11.2 kW)	53	52
	5 class (14 kW)	54	53
	6 class (15.5 kW)	56	55

Nighttime quiet operation function

Operation sound level selectable from 3 steps for the night mode

Mode 1. Automatic mode

Set on the outdoor PCB. Time of maximum temperature is memorised. The low operating mode will initiate 8 hours*¹ after the peak temperature in the daytime, and normal operation will resume 10 hours*² after that. The operation sound level for the night mode can be selected from 47 dB(A) (Step 1), 44 dB(A) (Step 2) and 41 dB(A) (Step 3).

Mode 2. Manual mode

Starting time and ending time can be input. (An external control adaptor for outdoor unit, DTA104A53/61/62, and a locally obtained timer are necessary.)

Mode 3. Combined mode

Combinations of modes 1 and 2 can be used depending on your needs.

*1. Initial setting. Can be selected from 6, 8 and 10 hours.

*2. Initial setting. Can be selected from 8, 9 and 10 hours.

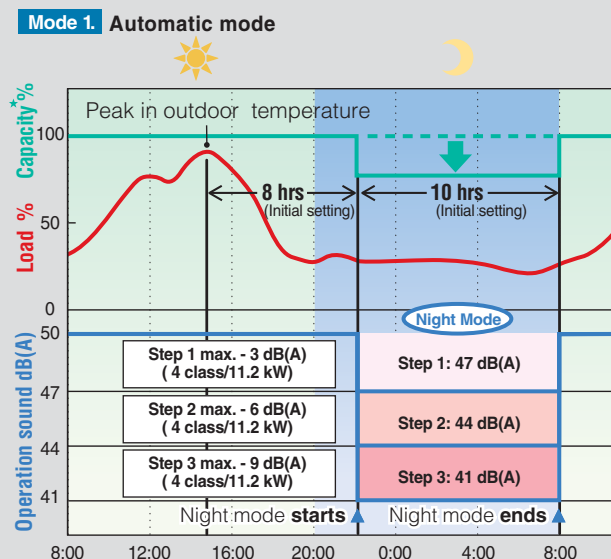

Note: • This function is available in setting at site.

• The relationship of outdoor temperature (load) and time shown in the graph is just an example.

* The capacity reduction rate differs depending on the operation sound level step selected.

A collection of cutting-edge technologies results in efficient and quiet operation.

The high efficiency compressor to achieve a higher COP

1 Compressor equipped with Reluctance DC motor

Daikin DC inverter models are equipped with the Reluctance DC motor for compressor. The Reluctance DC motor uses 2 different types of torque, neodymium magnet*1 and reluctance torque*2. This motor can reduce energy used because it generates more power with a smaller electric power than an AC or conventional DC motor.

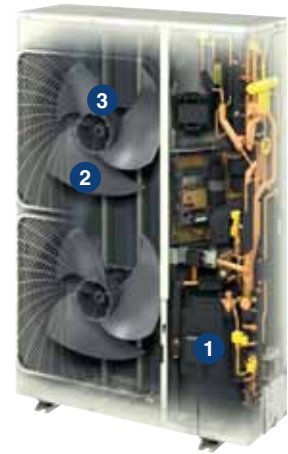

RXYMQ4PV4A
RXYMQ5PV4A
RXYMQ6PV4A

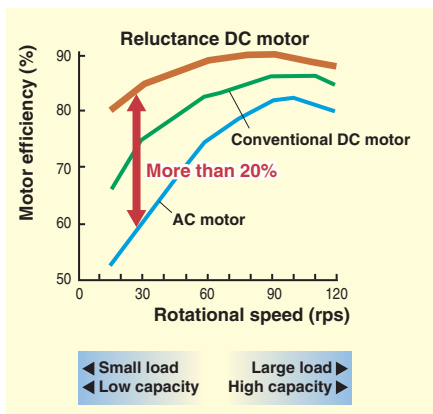

Note: Data are based on studies conducted under controlled conditions at a Daikin laboratory using Daikin products.

- *1 A neodymium magnet is approximately 10 times stronger than a standard ferrite magnet.
- *2 The torque created by the change in power between the iron and magnet parts.

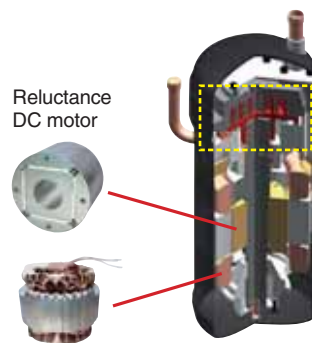

>> Smooth sine wave DC inverter

Use of an optimised sine wave smoothes motor rotation, further improving operating efficiency.

Sine wave DC inverter

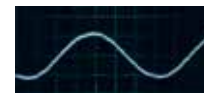

2 Smooth Air Inlet Bell Mouth and Aero Spiral Fan

These two features work to reduce sound. Guides are added to the bell mouth intake to reduce turbulence in the airflow generated by fan suction. The Aero Spiral Fan features fan blades with the bent blade edges, further reducing turbulence.



With the bent blade edge



Without the bent blade edge



Escaping eddies are sucked in by the bent blade edges, reducing overall turbulence.

3 DC fan motor

Efficiency improved in all areas compared to conventional AC motors, especially at low speeds.

DC fan motor structure

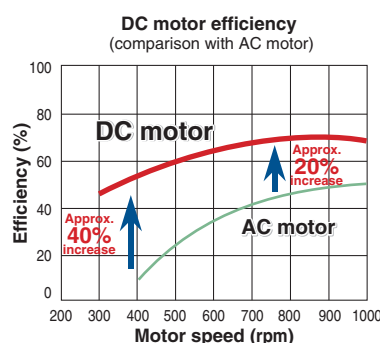

Note: Data are based on studies conducted under controlled conditions at a Daikin laboratory.

MAIN FEATURES

Design flexibility

VRVIII-S systems offer broad design flexibility with long refrigerant piping lengths and multiple indoor unit combinations, which provides generous freedom for office and shop design both inside and out.

Up to 9 indoor units can be connected to a single outdoor unit

Multiple indoor unit combinations are possible.* As many as 9 indoor units can be connected to a 6 class (15.5 kW) unit, making the VRVIII-S a versatile system.

* Total capacity index of connectable indoor units must be 50 - 130 % of the capacity index of the outdoor unit.

For a **6 class (15.5 kW)** installation

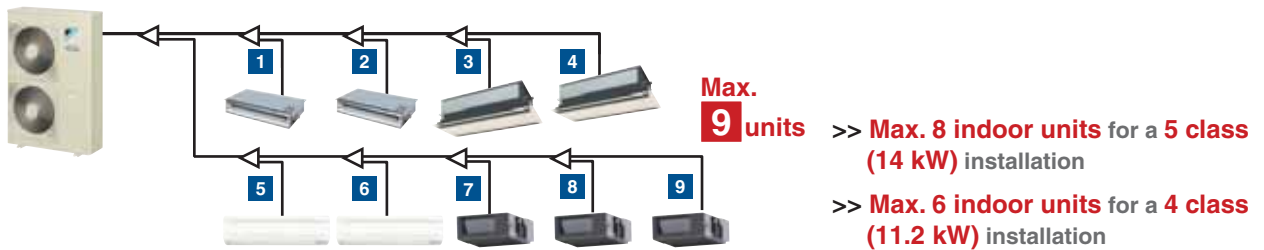

Long piping design possible

The VRVIII-S provides the long piping length possibility of 150 m, with a total piping length of 300 m. If the outdoor unit is installed above indoor units the level difference can be up to a maximum of 50 m. These generous allowances facilitate an extensive variety of system designs.

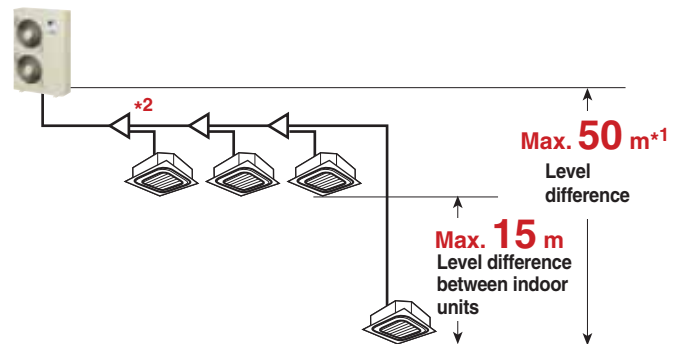

Actual piping length
Max. 150 m

Total piping length
Max. 300 m

Note: *1. 40 m when the outdoor unit is installed below indoor units.
*2. Maximum piping length between the indoor unit and the first branch is 40 m.

Wide operation temperature range

The operation range of the VRVIII-S system works to reduce limitations on installation locations. The operation temperature range for heating goes all the way down to -20°C, while cooling can be performed with outdoor temperatures as high as 46°C. Both these achievements are due to the adoption of a high-pressure dome-type compressor.

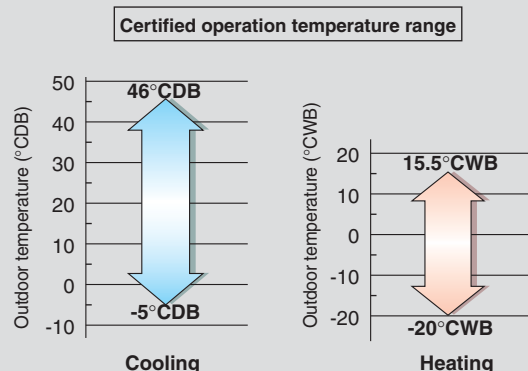

Easy installation

A variety of functions are provided that make installation easier, such as simple wiring and piping and automatic test operation.

Easy wiring

A printed circuit board has been adopted that is much easier to see and wire during installation.

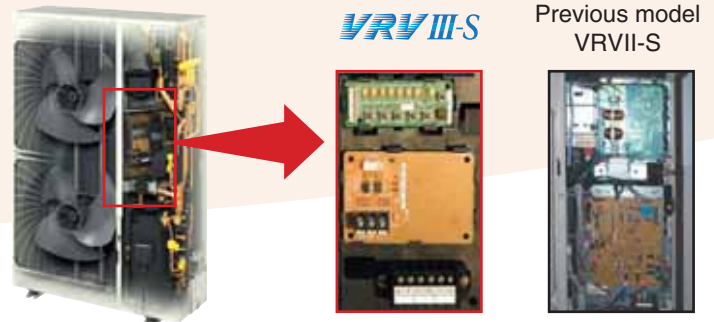

Automatic test operation

Simply press the test operation button after refrigerant charging is completed, and the unit performs an automatic system check, including wiring, shutoff valves, and sensors. The results are returned automatically after the check finishes.

Simple wiring and piping connection

Unique piping and wiring systems make it possible to install a VRVIII-S system quickly and easily.

>> Super wiring system

A super wiring system is used to enable shared use of the wiring between indoor and outdoor units and the central control wiring, with a relatively simple wiring operation. The DIII-NET communication system is employed to enable the use of advanced control systems.

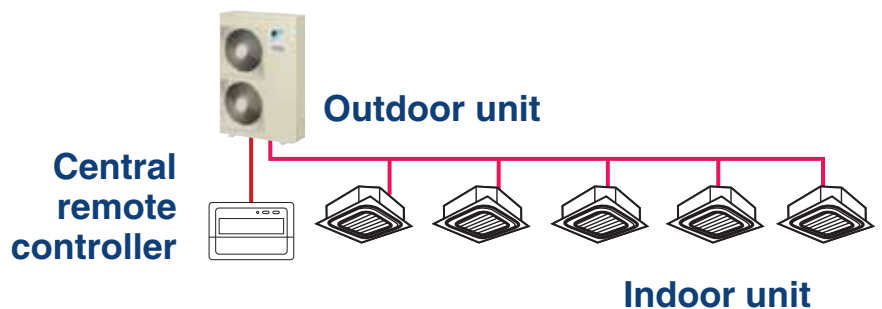

>> REFNET piping system

Daikin's advanced REFNET piping system makes installation easy. Only two main refrigerant lines are required in any one system. REFNET greatly reduces the imbalances in refrigerant flow between units, while using small-diameter piping.

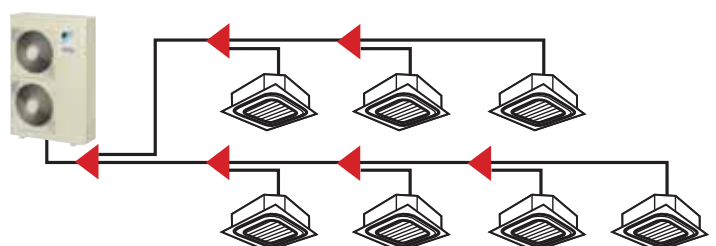

Control systems

The VRVIII-S system uses the same DIII-NET communication system as the VRV, enabling the use of advanced control systems.

Individual control systems

Wired remote controller (Option)



BRC1C62

- Digital display lets you set temperature in 1°C units.
- Lets you individually programme by timer the respective times for operation start and stop within a maximum of 72 hours.
- Equipped with a thermostat sensor in the remote controller that makes possible more comfortable room temperature control.
- Enables you to select cool/heat/fan operation mode with the indoor remote controller of your choice without using the cool/heat selector. (dependant on system)
- Equipped with self-diagnosis function that constantly monitors the system for malfunctions. Should a problem occur, the system alerts you of the problem through an alphanumeric code.
- The rubber switch and the oil-resisting resin casing have been adopted for durability.

* When the auto-swing function is not available, the message, THIS FUNCTION IS NOT AVAILABLE is displayed when the air direction adjustment button is pressed.

Wired remote controller with weekly schedule timer (Option)



BRC1D61

Adds advanced functions to those of the above wired remote controller.

- Includes ventilation mode and airflow rate switching, the main functions of Heat Reclaim Ventilator series.
- 24-hour clock function (1-hour backup for power failures)
- Programming function for each day of week.
- Scheduling possible of start/stop and temperature limit (5 settings/day)
- Programming can be enabled or disabled.
- Copy function for programmed schedules.

Notes: 1. Standard remote controllers (BRC1C62) not required.

2. If the BRC1D61 is connected to the centralised remote controllers (DCS303A51, DCS302CA61, DCS301BA61, DST301BA61), the schedule function is not available.

The wired remote controller supports a wide range of control functions

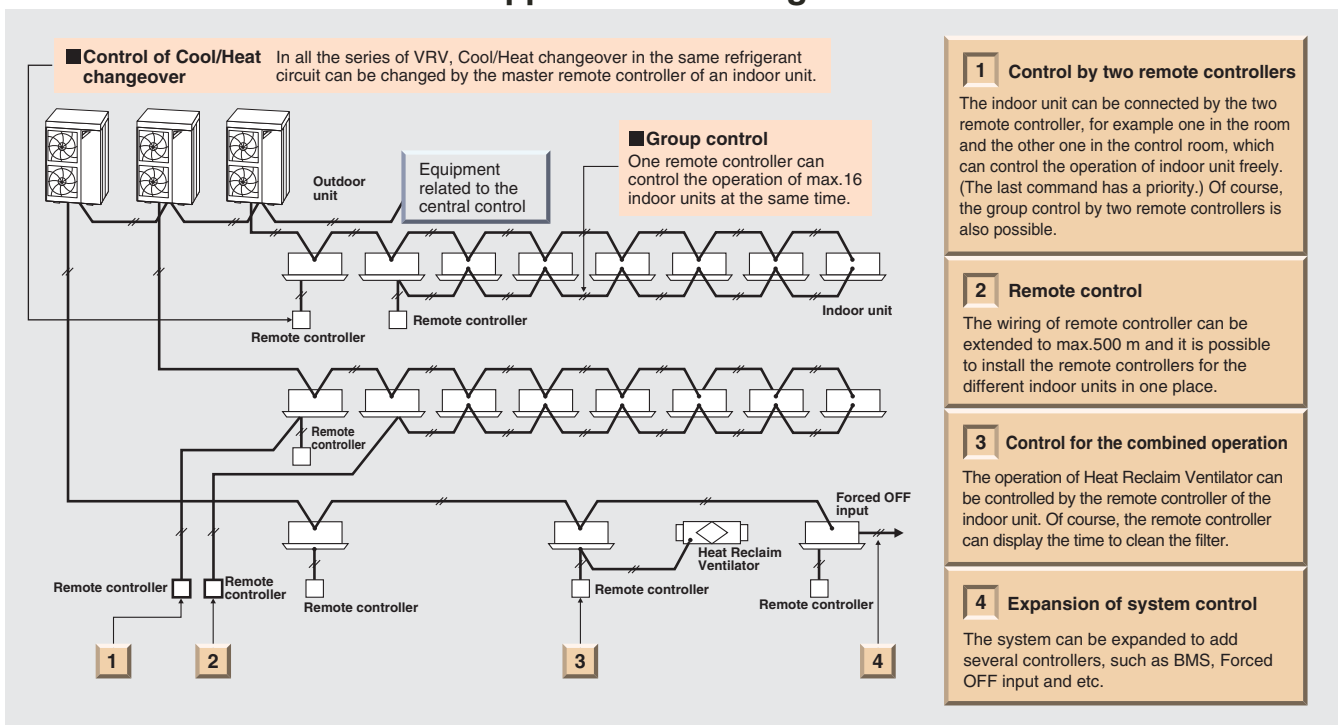

Wireless remote controller (Option)



Wireless remote controller

Signal receiver unit (Separate type)

- The same operation modes and settings as with wired remote controllers (BRC1C62 only) are possible.
- A compact signal receiver unit (separate type) to be mounted into a wall or ceiling is included.
- A signal receiver unit (installed type) for a Ceiling Mounted Cassette (Round Flow, Compact Multi Flow, Double Flow) type, Ceiling Suspended type and Wall Mounted type is mounted into the indoor unit.



Signal receiver unit can be installed on the panel
ex. Ceiling Mounted Cassette (Round Flow) type

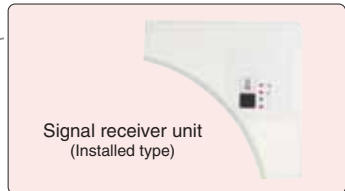

Signal receiver unit (Installed type)

*Wireless remote controller and signal receiver unit are sold as a set.
* Refer to page 37 for the name of each model.

Simplified remote controller (Option)



Exposed type (BRC2C51)

Concealed type (For hotel use) (BRC3A61)

- The remote controller has centralised its frequently used operation selectors and switches (on/off, operation mode, temperature setting and airflow volume), making itself suitable for use in hotel rooms or conference rooms.
- The exposed type remote controller is fitted with a thermostat sensor.



The concealed type remote controller smartly fits into a night table or console panel in a hotel room.

Wide variation of remote controllers for indoor units

	FXFQ	FXZQ	FXCQ	FXKQ	FXDQ	FXSYQ	FXDYQ	FXMQ	FXHQ	FXAQ	FXL(N)Q	FXUQ
Wired remote controller (BRC1C62)	●	●	●	●	●	●	●	●	●	●	●	●
Wired remote controller with weekly schedule timer (BRC1D61)	●	●	●	●	●	●	●	●	●	●	●	●
Wireless remote controller* (Installed type signal receiver unit)	●	●	●						●	●		●
Wireless remote controller* (Separate type signal receiver unit)				●	●	●	●	●			●	
Simplified remote controller (Exposed type) (BRC2C51)					●	●	●	●			●	
Simplified remote controller (Concealed type: for Hotel use) (BRC3A61)					●	●	●	●			●	

* Refer to page 37 for the name of each model.

CONTROL SYSTEMS

Centralised control systems

- Up to 64 groups of indoor units (128 units) can be centrally controlled.
- Optional controllers for centralised control can be combined and optimised in accordance with building scale and purpose.
- System integration with various air-conditioning peripheral equipment such as Heat Reclaim Ventilator is easy.
- Wiring can be run up to a total length of 2 km, and adapts easily to large-scale system expansion.

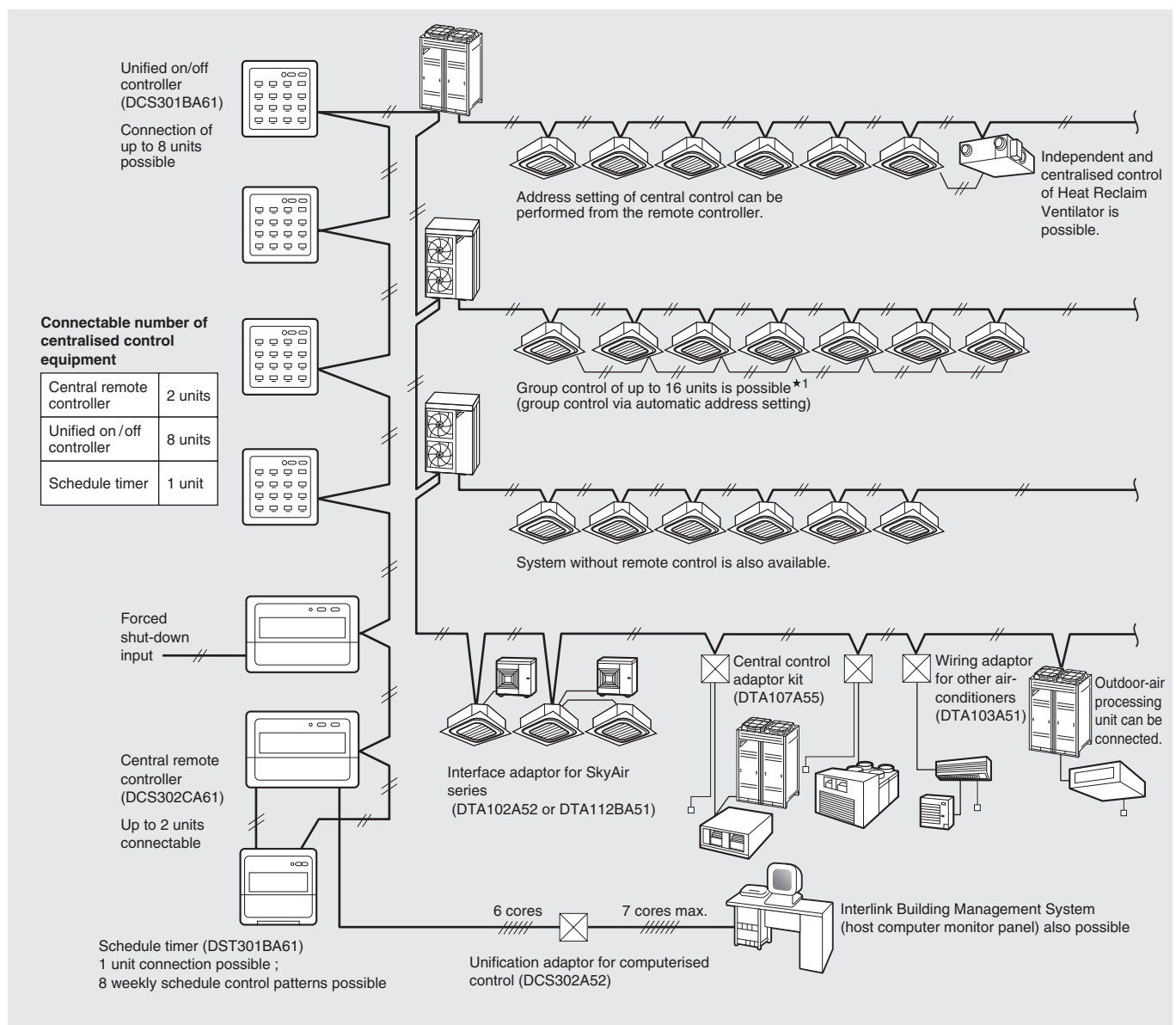

*1. Refer to page 7 for the total number of indoor units that can be connected to the outdoor unit.

• Certain indoor units limit the functions of some control systems.
For more details, please refer to the Engineering Data Book.



DCS303A51

Residential central remote controller* (Option)

Max. 16 groups of indoor units can be easily controlled with the large LCD panel.

- Max. 16 groups (128 indoor units) controllable
- Backlight and large LCD panel for easy readability
- ON/OFF, temperature settings and scheduling can be controlled individually for indoor units.
- All indoor units can be turned on or off at once with "ALL" button.
- Each group has a dedicated button for convenience.
- Outside temperature display

* For residential use only. Cannot be used with other centralised control equipment.



DCS302CA61

Central remote controller (Option)

Max. 64 groups (zones) of indoor units can be controlled individually same as LCD Remote controller.

- Max. 64 groups (128 indoor units) controllable
- Max. 128 groups (128 indoor units) are controllable by using 2 central remote controllers, which can control from 2 different places.
- Zone control
- Malfunction code display
- Max. wiring length 1,000 m (Total: 2,000 m)
- Connectable with Unified ON/OFF controller, schedule timer and BMS system
- Airflow volume and direction can be controlled individually for indoor units in each group operation.
- Ventilation volume and mode can be controlled for Heat Reclaim Ventilator.
- Up to 4 ON/OFF pairs can be set per day by connecting a schedule timer.



DCS301BA61

Unified ON/OFF controller (Option)

Max. 16 groups of indoor units can be operated simultaneously/individually.

- Max. 16 groups (128 indoor units) controllable
- 2 remote controllers can be used to control from 2 different places.
- Operating status indication (Normal operation, Alarm)
- Centralised control indication
- Max. wiring length 1,000 m (Total: 2,000 m)
- Compact size casing (Thickness: 16 mm)
- Connectable with Central Remote controller, Schedule timer and BMS system



DST301BA61

Schedule timer (Option)

Max. 128 indoor units can be operated as programmed schedule.

- Max. 128 indoor units controllable
- When used in combination with a central remote controller, a maximum of 8 weekly schedule patterns can be set, while the central controller can be used to select desired zones. Up to 2 ON/OFF pairs can be set per day.
- Max. 48 hours back up power supply
- Max. wiring length 1,000 m (Total: 2,000 m)
- Compact size casing (Thickness: 16 mm)
- Connectable with Central Remote controller, Unified ON/OFF controller and BMS system

CONTROL SYSTEMS

Advanced control systems

Intelligent Touch Manager New

One touch selection to total air comfort

Daikin proudly introduces its new *intelligent Touch Manager*, a VRV system controller featuring an array of simple, useful system management functions for added value.

Up to 2,560 groups (5,120 indoor units) can be controlled by one system

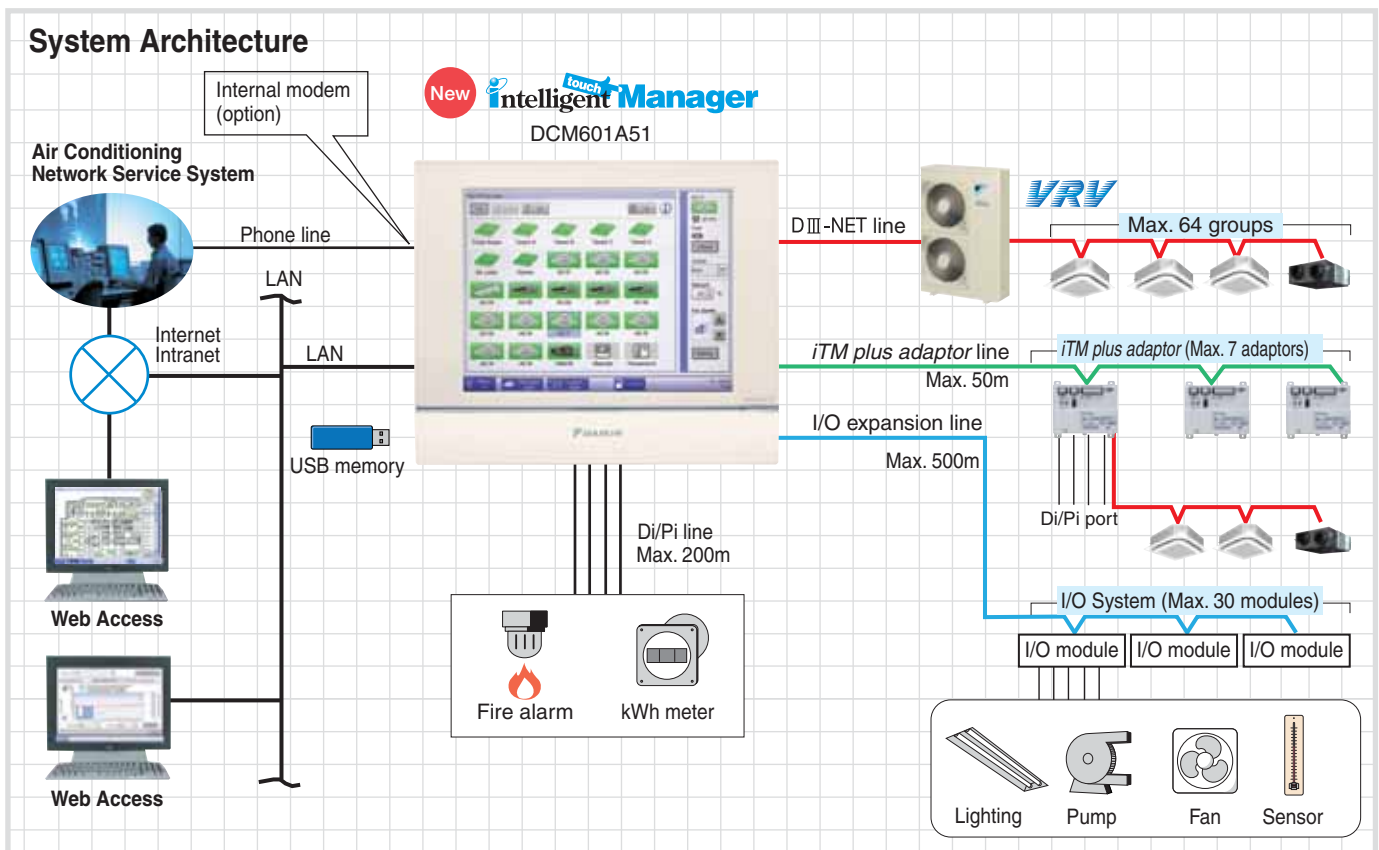

Features

Central control

- Handy area settings simplify detailed management of VRV.
- Display of floor plans enables a quick search of desired air conditioning units.
- Operation history shows manner of control and origin in past operations of air conditioning units.

Remote access

- Remote access with a PC allows total air conditioning management using the same type of screens as those displayed in the *intelligent Touch Manager*.
- Authorised users can centrally control individual air conditioning units from their own computers.

Automatic control

- VRVs are controlled automatically throughout the year by the schedule function.
- Interlocking VRVs and other equipment enables easy automation of building facilities operation.
- Setback adjusts temperature settings even when rooms are unoccupied.

Energy management

- The Energy Navigator feature simplifies energy management by tracking energy consumption data and identifying inefficient operation.

Troubleshooting

- Contact information of maintenance contractors can be registered and displayed.
- E-mails are sent automatically to alert of malfunctions and potential trouble.
- The *intelligent Touch Manager* can link to the Air Conditioning Network Service System for 24-hour monitoring of operating conditions and status.

Scalability

- A single *intelligent Touch Manager* can manage a small building or be expanded to handle medium- to large-sized buildings.
- Large building properties can also take advantage of the *iTM integrator* to link up and expand system up to 5 *intelligent Touch Managers* for integrated control.

Intelligent touch Controller

Communication functions in the user-friendly icon-based multilingual controller simplify centralised control of the VRV system.

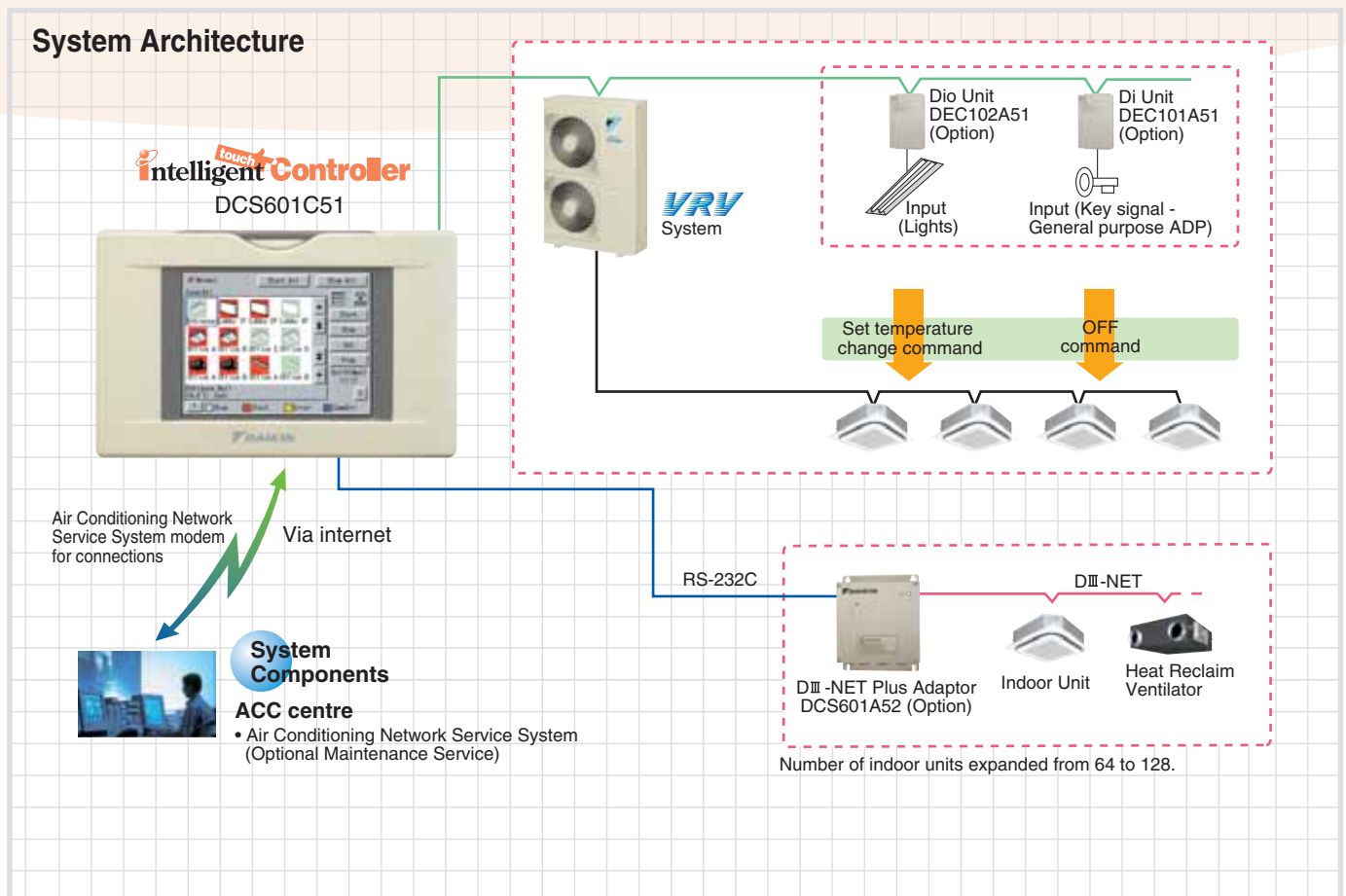

Features

- Colour LCD touch panel icon display
- Small manageable size
- Simplified engineering
- Multi language (English, French, Italian, German, Spanish, Dutch, Portuguese, Chinese and Korean)
- Yearly schedule
- Auto heat/cool change-over
- Temperature limitation
- Enhanced history function
- Simple Interlock Function
- Built-in modem for connecting to Air Conditioning Network Service System (Option)
- Doubling of number of connectable indoor units by adding a DIII-NET Plus Adaptor (Option)
- Management of facilities/equipment other than A/C units (By adding Dio unit or Di unit)



Ceiling Mounted Cassette (Round Flow) Type

FXFQ25P/FXFQ32P/FXFQ40P
FXFQ50P/FXFQ63P/FXFQ80P
FXFQ100P/FXFQ125P



360° airflow improves temperature distribution and offers a comfortable living environment.

- The industry's first* Round Flow Ceiling Mounted Cassette type offers 360° airflow with improved temperature distribution.

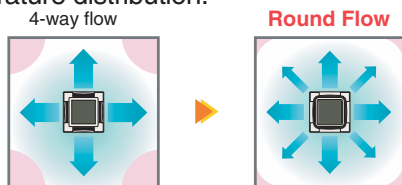

There are areas of uneven temperature.

There are much fewer areas of uneven temperature.

* As of April 2004, the release date for Japan.

- All models are lighter than the conventional ones.
Ex: Models FXFQ25P-50P are 4.5 kg lighter (reduced from 24 kg to 19.5 kg).

- Drain pump is equipped as a standard accessory, and the lift height has been improved from 750 mm to 850 mm.

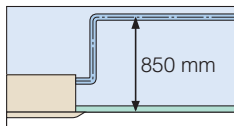

- A modern sophisticated decoration panel has been applied, with a panel surface that has been treated with a dirt-repellant coating.

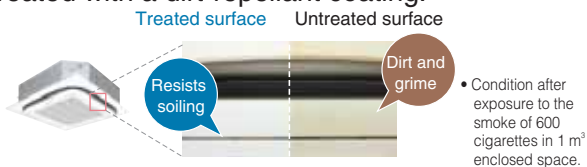

- Control of the airflow rate has been improved from 2-step to 3-step control.

- Low operation sound level (dB(A))

FXFQ-P	25/32	40	50	63	80	100	125
Sound level (HH/H/L)	30/28.5/27	31/29/27	32/29.5/27	34/31/28	36/33.5/31	43/37.5/32	44/39/34



- An antibacterial treatment that uses silver ions has been applied to the drain pan, preventing the growth of slime, mould and bacteria that cause blockages and odours.
- The horizontal louvres prevent dew condensation. Their non-flocking surfaces, which repel dirt, are easy to clean.
- The air filter has an anti-mould and antibacterial treatment that prevents the growth of mould generated from dust or moisture that may adhere to the filter.

- Example of airflow patterns: 360° airflow is available, as well as 2- to 4-way flows, so you can choose the most suitable airflow pattern depending on location or room layout.

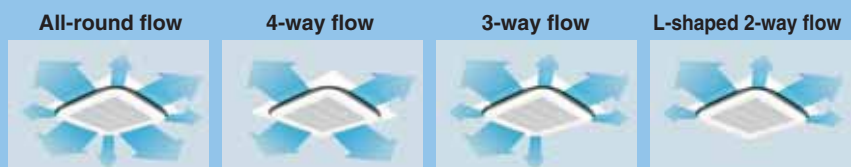

Note: Whatever the discharge direction, the same type of panel is used. If installing for other than all-round flow, an air discharge outlet sealing member (option) must be used to close each unused outlet.

Ceiling Mounted Cassette (Compact Multi Flow) Type

FXZQ20M/FXZQ25M
FXZQ32M/FXZQ40M
FXZQ50M



Quiet, compact, and designed for user comfort

- Dimensions correspond with 600 mm × 600 mm architectural module ceiling design specifications.

- Low operation sound level

(240 V)(dB(A))

FXZQ-M	20/25	32	40	50
Sound level (H/L)	32/26	34/28	37/29	42/35

- Comfortable airflow

1 Wide discharge angle: 0° to 60°

- Auto swing

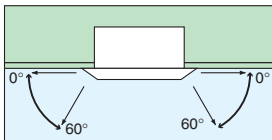

- Fixed angles: 5 levels

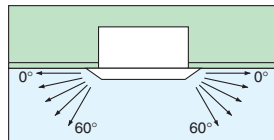

*Angles can be also set on site to prevent drafts (0°-35°) or soiling of the ceiling (25°-60°), other than standard setting (0°-60°).

2 2-, 3-, and 4-way airflow patterns are available, enabling installation in the corner of a room.

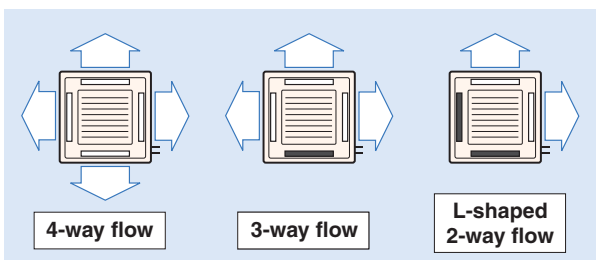

*For 3-way or 2-way flow installation, the sealing member for air discharge outlet (option) must be used to close each unused outlet.



- Drain pump is equipped as a standard accessory with 750 mm lift.

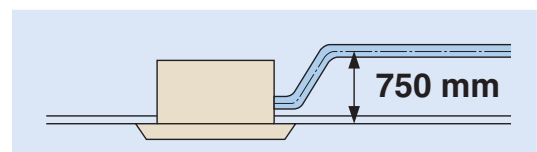

Ceiling Mounted Cassette (Double Flow) Type

FXCQ20M/FXCQ25M/FXCQ32M
 FXCQ40M/FXCQ50M/FXCQ63M
 FXCQ80M/FXCQ125M



Thin, lightweight, and easy to install in shallow ceiling spaces

- The low profile unit (only 305 mm high) can be installed in a ceiling space as shallow as 350 mm. All models feature a compact design with a depth of only 600 mm.

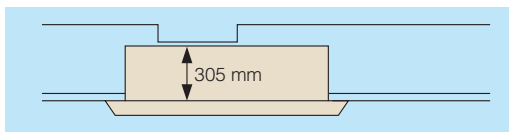

(When a high-efficiency filter is attached, the unit's height is 400 mm.)

- Low operation sound level (240 V)(dB(A))

FXCQ-M	20	25/32	40/50	63	80	125
Sound level (H/L)	34/29	36/30	37/32	39/34	41/36	46/40

- Designed with higher airflow suitable for high ceiling application up to 3 metres.
- Providing 2 different settings of standard and ceiling soiling prevention, the auto swing mechanism achieves even distribution of airflow and room temperature.
- Drain pump is equipped as a standard accessory with 600 mm lift.

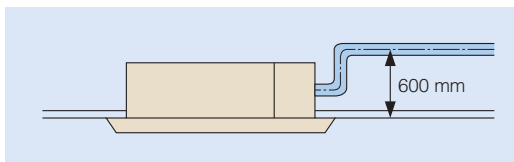

- Two types of optional high-efficiency filter are available (65% and 95%, colourimetric method).
- A long-life filter (maintenance free up to one year*) is equipped as a standard accessory.
* 8 hr/day, 25 day/month. For dust concentration of 0.15 mg/m³
- Major maintenance work can be performed by removing the panel. A flat-type suction grille and a detachable blade make cleaning easy.

Ceiling Mounted Cassette Corner Type

**FXKQ25MA/FXKQ32MA
FXKQ40MA/FXKQ63MA**



Slim design for flexible installation

- Slim body needs only 220 mm space above the ceiling. If you use a panel spacer (option), the unit can be installed in the minimum space of 195 mm.

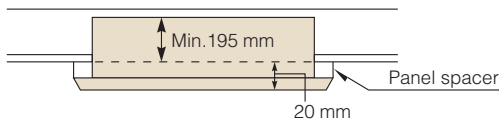

- Single-flow type allows effective air discharge from corner or from drop-ceiling.

- Drain pump is equipped as a standard accessory with 500 mm lift.

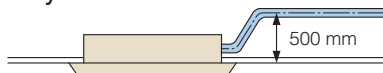

- Providing 3 different settings of standard, draft prevention and ceiling soiling prevention, the auto swing mechanism achieves even distribution of airflow and room temperature.

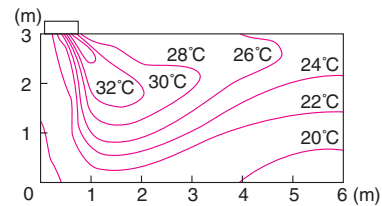

- Front discharge is possible with an air discharge unit (option), which allows the installation in the drop-ceiling or sagging wall.

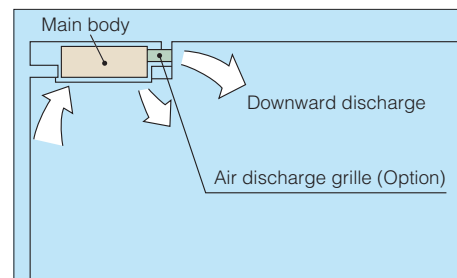

*Set for front discharge using a suspended ceiling.

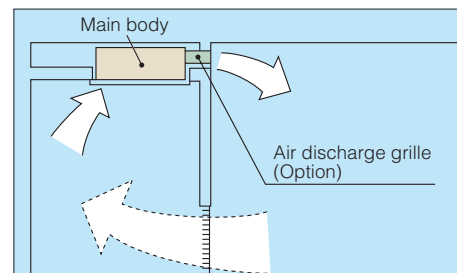

*Downward discharge is shut off and air is blown straight out (front discharge).

- A long-life filter (maintenance free up to one year*) is equipped as a standard accessory.

* 8 hr/day, 25 day/month. For dust concentration of 0.15 mg/m³

Slim Ceiling Mounted Duct Type



Slim design, quietness and static pressure switching

Suited for use in drop-ceilings!

FXDQ20PB/FXDQ25PB/FXDQ32PB

- Only 700 mm in width and 23 kg in weight, this model is suitable to install in limited spaces like drop-ceilings in hotels.

Great for hotel use!

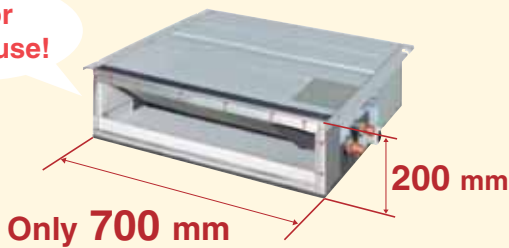

FXDQ40NB/FXDQ50NB/FXDQ63NB

- Only 200 mm in height, this model can be installed in rooms with as little as 240 mm depth between the drop-ceiling and ceiling slab.

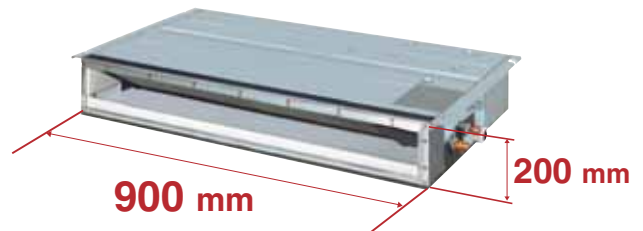

* 1,100 mm in width for the FXDQ63NB model.

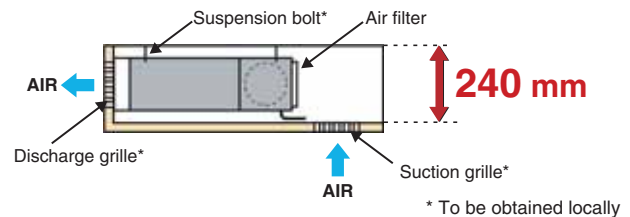

* To be obtained locally



- Control of the airflow rate has been improved from 2-step to 3-step control.

- Low operation sound level (dB(A))

FXDQ-PB/NB	20/25/32	40	50	63
Sound level (HH/H/L)	33/31/29	34/32/30	35/33/31	36/34/32

* The values of operation sound level represent those for rear-suction operation. Sound level values for bottom-suction operation can be obtained by adding 5 dB(A).

* Values are based on the following conditions:
FXDQ-PB: external static pressure of 10 Pa; FXDQ-NB: external static pressure of 15 Pa.

- External static pressure selectable by remote controller switching make this indoor unit a very comfortable and flexible model.

10 Pa-30 Pa/factory set: 10 Pa for FXDQ-PB models.
15 Pa-44 Pa/factory set: 15 Pa for FXDQ-NB models.

- Drain pump is equipped as a standard accessory with 750 mm lift.

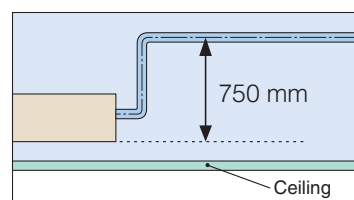

Ceiling Mounted Built-in Type



FXSYQ20M/FXSYQ25M/FXSYQ32M
 FXSYQ40M/FXSYQ50M/FXSYQ63M
 FXSYQ80M/FXSYQ100M/FXSYQ125M

Highly flexible for various application

- Highly flexible installation is possible with a complete lineup of optional kits to satisfy various needs, such as the design concept, interior decoration and so on.

- The unit can be installed, if there is a space of 350 mm above ceiling. (when suction panel is used.)

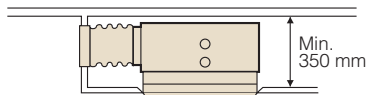

- Drain pump is equipped as a standard accessory with 250 mm lift.

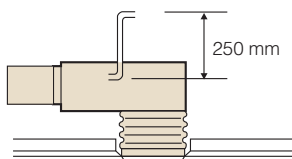

- High external static pressure allows the use of flexible ducts of various length.

- Low operation sound level (230 V)(dB(A))

FXSYQ-M	20/25/32	40	50	63	80/100	125
Sound level (H/L)	41/33.5	41/34.5	43/37	45/38.5	48/43	49/41.5

*The values of operation sound level are based on Australian Standard 1217.6-1985. Measurement is based on bottom-return air entry.

Installation examples (* Optional parts)

Standard

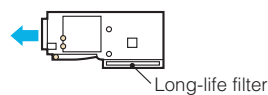

Cassette style (standard filter)

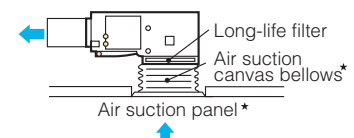

With duct

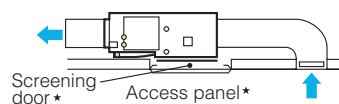

Cassette style (high efficiency filter)

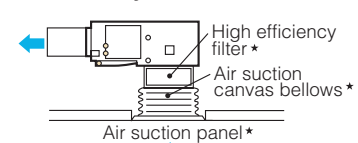

Ceiling return

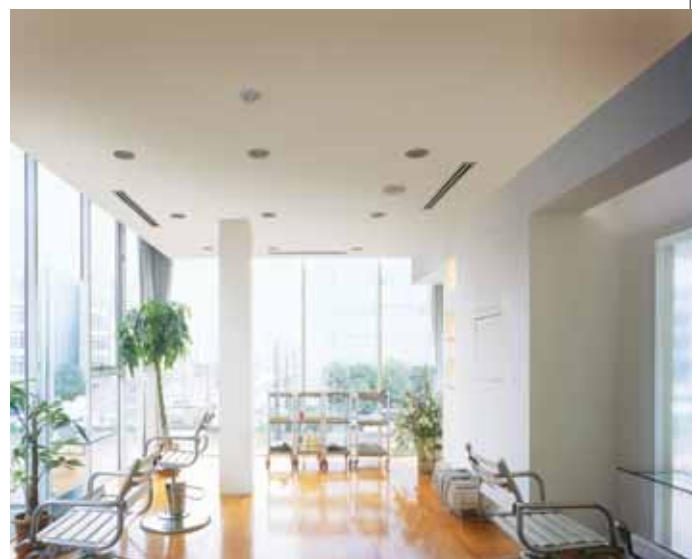
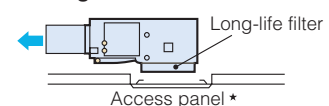

Ceiling Concealed (Duct) Type

FXDYQ80MA/FXDYQ100MA
FXDYQ125MA/FXDYQ145MA



High static pressure offers flexible duct design that blends in with interior décor in stores and offices

- Hi-X heat exchanger coils provide even more energy efficiency.
- High external static pressure of 120 Pa allows comprehensive duct layout for various applications.
- Design of indoor units allows installation in limited roof spaces.
- Return air spigots included for ease of installation.
- Two external static pressure settings for added flexibility.
- Quiet yet powerful supply air fan.
- High strength galvanised steel casing.



Ceiling Mounted Duct Type

**FXMQ20P/FXMQ25P/FXMQ32P
FXMQ40P/FXMQ50P/FXMQ63P
FXMQ80P/FXMQ100P/FXMQ125P
FXMQ140P**



Middle and high static pressure allows for flexible duct design

- A DC fan motor increases the external static pressure capacity range to include middle to high static pressures, increasing design flexibility.

30 Pa–100 Pa for FXMQ20P-32P

30 Pa–160 Pa for FXMQ40P

50 Pa–200 Pa for FXMQ50P-125P

50 Pa–140 Pa for FXMQ140P

- All models are only 300 mm in height, an improvement over the 390 mm height of conventional models. The weight of the FXMQ40P has been reduced from 44 kg to 28 kg.



Easy installation in buildings with narrow ceiling spaces

- Drain pump is equipped as a standard accessory with 700 mm lift.

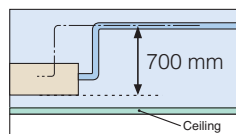

- Control of the airflow rate has been improved from 2-step to 3-step control.

● Low operation sound level

(dB(A))

FXMQ-P	20/25	32	40	50	63	80/100	125	140
Sound level (HH/H/L)	33/31/29	34/32/30	39/37/35	41/39/37	42/40/38	43/41/39	44/42/40	46/45/43

● Energy-efficient

- The adopted DC fan motor is much more efficient than the conventional AC motor, yielding an approximate 20% decrease in energy consumption (FXMQ125P).

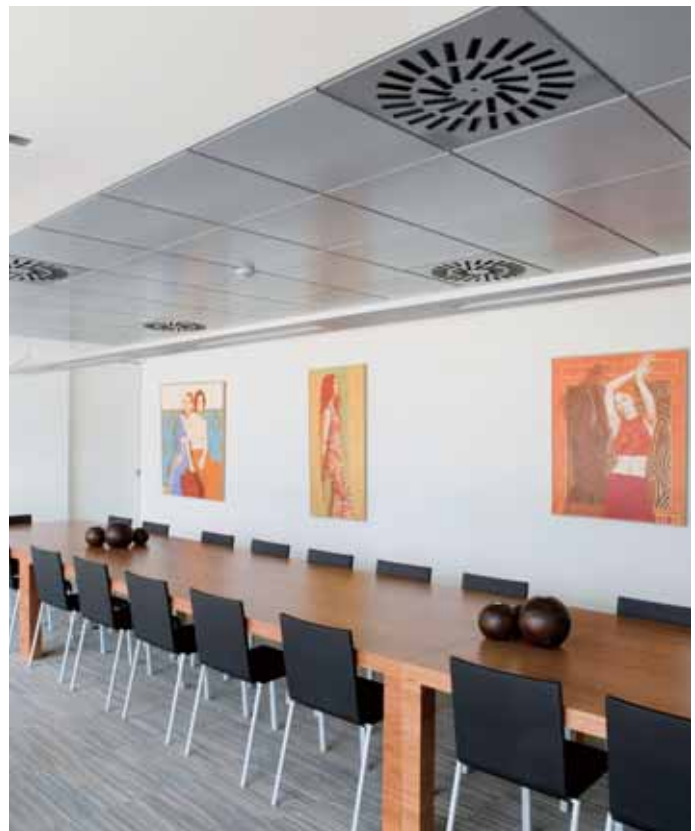

● Improved ease of installation

- Airflow rate can be controlled using a remote controller during test operation. With the conventional model, the airflow rate was controlled from the PC board. It is automatically adjusted to the range between approximately $\pm 10\%$ of the rated HH tap airflow for FXMQ20P-125P.

● Improved ease of maintenance

- The drain pan can be detached for easy cleaning. An antibacterial treatment that uses silver ions has been applied to the drain pan, preventing the growth of slime, mould and bacteria that cause blockages and odours.

Ceiling Suspended Type

**FXHQ32MA/FXHQ63MA
FXHQ100MA**



Slim body with quiet and wide airflow

●Adoption of QUIET STREAM FAN

Uses the quiet stream fan and many advanced technologies.

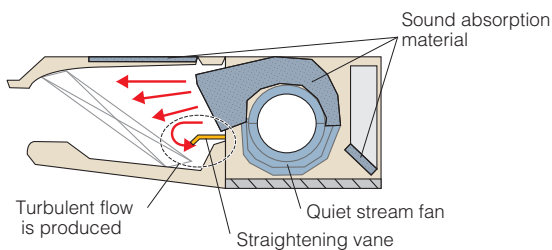

●Low operation sound level

(dB(A))

FXHQ-MA	32	63	100
Sound level (H/L)	36/31	39/34	45/37

●Installation is easy

- Drain pump kit (option) can be easily incorporated.

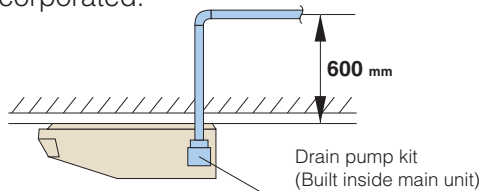

●Wide air discharge openings produce a spreading 100° airflow.

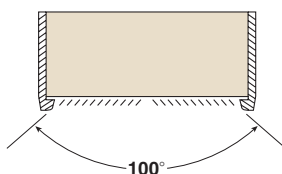

●Maintenance is easy

- Non-dew Flap with no implanted bristles

Bristle-free Flap minimises contamination and makes cleaning simpler.



Non-dew Flap

- Easy-to-clean flat design
- Maintenance is easier because servicing can be performed from below the unit.
- A long-life filter (maintenance free up to one year*) is equipped as a standard accessory.

* 8 hr/day, 25 day/month. For dust concentration of 0.15 mg/m³

Wall Mounted Type

New

**FXAQ20P/FXAQ25P
FXAQ32P/FXAQ40P
FXAQ50P/FXAQ63P**



Stylish flat panel design harmonised with your interior décor

- Stylish flat panel design creates a graceful harmony that enhances any interior space.
- Flat panel can be cleaned with only the single pass of a cloth across their smooth surface. Flat panel can also be easily removed and washed for more thorough cleaning.

- Low operation sound level (dB(A))

FXAQ-P	20	25	32	40	50	63
Sound level (H/L)	35/31	36/31	38/31	39/34	42/37	47/41

- Drain pan and air filter can be kept clean by mould-proof polystyrene.
- Vertical auto-swing realises efficiency of air distribution. The louvre closes automatically when the unit stops.
- 5 steps of discharge angle can be set by remote controller.
- Discharge angle is automatically set at the same angle as the previous operation when restarting. (Initial setting: 10° for cooling and 70° for heating)

- Flexible installation

- Drain pipe can be fitted to from either left or right sides.



- Drain pump kit is available as optional accessory, which lifts the drain 1,000 mm from the bottom of the unit.

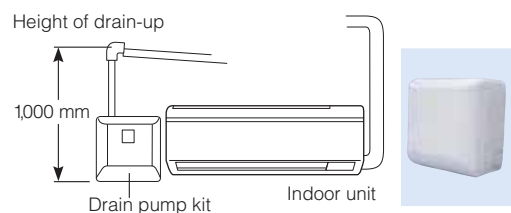

Floor Standing Type

**FXLQ20MA/FXLQ25MA
FXLQ32MA/FXLQ40MA
FXLQ50MA/FXLQ63MA**



Suitable for perimeter zone air conditioning

- Floor Standing types can be hung on the wall for easier floor cleaning. Running the piping from the back allows the unit to be hung on walls. Cleaning under the unit, where dust tends to accumulate, is considerably easier.
- The adoption of a fibre-less discharge grille featuring an original design to prevent condensation also helps prevent staining and makes cleaning easier.
- A long-life filter (maintenance free up to one year*) is equipped as a standard accessory.

* 8 hr/day, 25 day/month. For dust concentration of 0.15 mg/m³

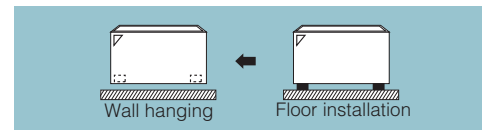

Concealed Floor Standing Type

**FXNQ20MA/FXNQ25MA
FXNQ32MA/FXNQ40MA
FXNQ50MA/FXNQ63MA**



Designed to be concealed in the perimeter skirting-wall

- The unit is concealed in skirting-wall of perimeter, that enables to create high class interior design.
- The connecting port faces downward, greatly facilitating on-site piping work.
- A long-life filter (maintenance free up to one year*) is equipped as a standard accessory.

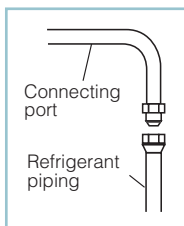

* Applies also to Floor Standing type (FXLQ-MA).

* 8 hr/day, 25 day/month. For dust concentration of 0.15 mg/m³



Ceiling Suspended Cassette Type

FXUQ71MA
FXUQ100MA
FXUQ125MA



This thin indoor unit achieves optimum air distribution, and can be installed without the need for ceiling cavity

- Depending on installation site requirements or room conditions, 2-way, 3-way and 4-way discharge patterns are available.

- 4-way airflow from the centre of the store.



- The 3-way airflow can distribute comfortable air throughout the room.

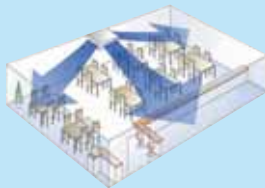

- Only one unit is needed to distribute comfortable air throughout an L-shaped store.

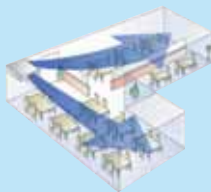

Connection unit Connection unit is the device for connecting above indoor unit to VRVIII-S.

BEVQ71MA/BEVQ100MA/BEVQ125MA

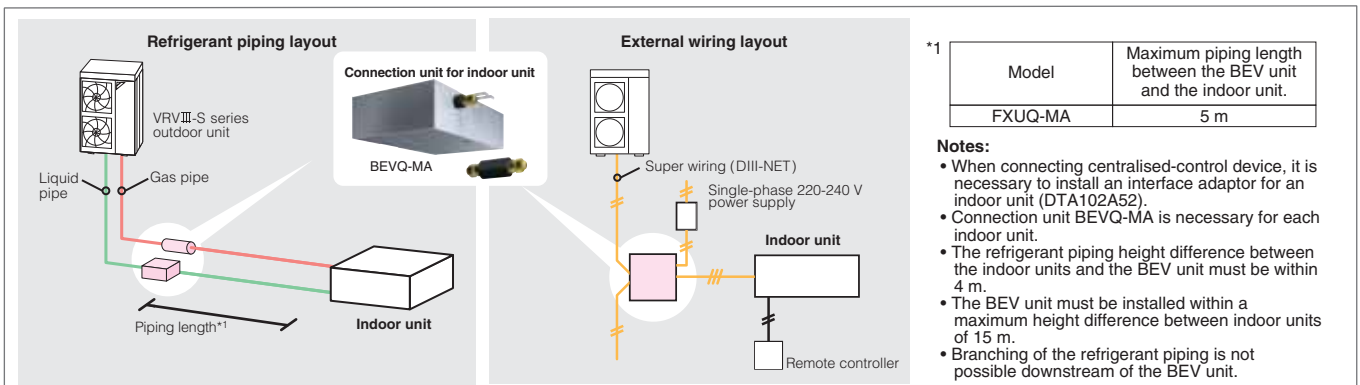

SPECIFICATIONS

● INDOOR UNITS ●

Ceiling Mounted Cassette (Round Flow) Type



MODEL		FXFQ25PVE	FXFQ32PVE	FXFQ40PVE	FXFQ50PVE	FXFQ63PVE	FXFQ80PVE	FXFQ100PVE	FXFQ125PVE	
Power supply		1-phase, 220-240 V/220 V, 50/60 Hz								
Cooling capacity	kcal/h (*1)	2,500	3,200	4,000	5,000	6,300	8,000	10,000	12,500	
	Btu/h (*1)	9,900	12,600	16,000	19,800	24,900	31,700	39,600	49,500	
	kW	(*1)	2.9	3.7	4.7	5.8	7.3	9.3	11.6	14.5
		(*2)	2.8	3.6	4.5	5.6	7.1	9.0	11.2	14.0
Heating capacity	kcal/h	2,800	3,400	4,300	5,400	6,900	8,600	10,800	13,800	
	Btu/h	10,900	13,600	17,100	21,500	27,300	34,100	42,700	54,600	
	kW	3.2	4.0	5.0	6.3	8.0	10.0	12.5	16.0	
Power consumption	Cooling	kW	0.033	0.033	0.047	0.052	0.066	0.093	0.187	0.209
	Heating		0.027	0.027	0.034	0.038	0.053	0.075	0.174	0.200
Casing		Galvanised steel plate								
Airflow rate (HH/H/L)	ℓ/s	216/191/166	216/191/166	250/216/183	266/225/183	316/275/225	350/300/250	533/433/333	550/466/375	
	m ³ /min	13/11.5/10	13/11.5/10	15/13/11	16/13.5/11	19/16.5/13.5	21/18/15	32/26/20	33/28/22.5	
Sound level (HH/H/L)	dB(A)	30/28.5/27	30/28.5/27	31/29/27	32/29.5/27	34/31/28	36/33.5/31	43/37.5/32	44/39/34	
Sound power (HH/H/L)	dB(A)	48/46.5/45	48/46.5/45	49/47/45	50/47.5/45	52/49/46	53/51.5/49	60/54.5/50	61/56/52	
Dimensions (H×W×D)	mm	246×840×840	246×840×840	246×840×840	246×840×840	246×840×840	246×840×840	288×840×840	288×840×840	
Machine weight	kg	19.5	19.5	19.5	19.5	22	22	25	25	
Piping connections	Liquid (Flare)	mm	φ 6.4	φ 6.4	φ 6.4	φ 6.4	φ 9.5	φ 9.5	φ 9.5	φ 9.5
	Gas (Flare)		φ 12.7	φ 12.7	φ 12.7	φ 12.7	φ 15.9	φ 15.9	φ 15.9	φ 15.9
	Drain		VP25 (External Dia, 32/Internal Dia, 25)							
Panel (Option)	Model	BYCP125K-W1								
	Colour	Fresh white								
	Dimensions (H×W×D)	mm	50×950×950	50×950×950	50×950×950	50×950×950	50×950×950	50×950×950	50×950×950	50×950×950
	Weight	kg	5.5	5.5	5.5	5.5	5.5	5.5	5.5	5.5

Ceiling Mounted Cassette (Compact Multi Flow) Type



MODEL		FXZQ20MVE	FXZQ25MVE	FXZQ32MVE	FXZQ40MVE	FXZQ50MVE	
Power supply		1-phase, 220-240 V/220 V, 50 Hz/60 Hz					
Cooling capacity	kcal/h (*1)	2,000	2,500	3,200	4,000	5,000	
	Btu/h (*1)	7,800	9,900	12,600	16,000	19,800	
	kW	(*1)	2.3	2.9	3.7	4.7	5.8
		(*2)	2.2	2.8	3.6	4.5	5.6
Heating capacity	kcal/h	2,200	2,800	3,400	4,300	5,400	
	Btu/h	8,500	10,900	13,600	17,100	21,500	
	kW	2.5	3.2	4.0	5.0	6.3	
Power consumption	Cooling	kW	0.073	0.073	0.076	0.089	0.115
	Heating		0.064	0.064	0.068	0.080	0.107
Casing		Galvanised steel plate					
Airflow rate (H/L)	ℓ/s	150/116	150/116	158/125	183/133	233/166	
	m ³ /min	9/7	9/7	9.5/7.5	11/8	14/10	
Sound level (H/L)	240 V	dB(A)	32/26	32/26	34/28	37/29	42/35
Sound power (H)	240 V	dB(A)	49	49	51	54	59
Dimensions (H×W×D)	mm	286×575×575					
Machine weight	kg	18					
Piping connections	Liquid (Flare)	mm	φ 6.4	φ 6.4	φ 6.4	φ 6.4	φ 6.4
	Gas (Flare)		φ 12.7	φ 12.7	φ 12.7	φ 12.7	φ 12.7
	Drain		VP20 (External Dia, 26/Internal Dia, 20)				
Panel (Option)	Model	BYFQ60B8W1					
	Colour	White (6.5Y9.5/0.5)					
	Dimensions (H×W×D)	mm	55×700×700	55×700×700	55×700×700	55×700×700	55×700×700
	Weight	kg	2.7	2.7	2.7	2.7	2.7

Note: Specifications are based on the following conditions;

- Cooling: (*1) Indoor temp.: 27°CDB, 19.5°CWB, Outdoor temp.: 35°CDB, Equivalent piping length: 7.5 m, Level difference: 0 m.
(*2) Indoor temp.: 27°CDB, 19°CWB, Outdoor temp.: 35°CDB, Equivalent piping length: 7.5 m, Level difference: 0 m.
- Heating: Indoor temp.: 20°CDB, Outdoor temp.: 7°CDB, 6°CWB, Equivalent piping length: 7.5 m, Level difference: 0 m.
- Capacity of indoor unit is only for reference. Actual capacity of indoor unit is based on the total capacity index.
(See Engineering Data Book for details.)
- Sound level: Anechoic chamber conversion value, measured at a point 1.5 m downward from the unit centre.
During actual operation, these values are normally somewhat higher as a result of ambient conditions.

● INDOOR UNITS ●

Ceiling Mounted Cassette (Double Flow) Type



MODEL		FXCQ20MVE	FXCQ25MVE	FXCQ32MVE	FXCQ40MVE	FXCQ50MVE	FXCQ63MVE	FXCQ80MVE	FXCQ125MVE		
Power supply		1-phase, 220-240 V/220 V, 50/60 Hz									
Cooling capacity	kcal/h(*1)	2,000	2,500	3,200	4,000	5,000	6,300	8,000	12,500		
	Btu/h(*1)	7,800	9,900	12,600	16,000	19,800	24,900	31,700	49,500		
	kW	(*1)	2.3	2.9	3.7	4.7	5.8	7.3	9.3	14.5	
(*2)		2.2	2.8	3.6	4.5	5.6	7.1	9.0	14.0		
Heating capacity	kcal/h	2,200	2,800	3,400	4,300	5,400	6,900	8,600	13,800		
	Btu/h	8,500	10,900	13,600	17,100	21,500	27,300	34,100	54,600		
	kW	2.5	3.2	4.0	5.0	6.3	8.0	10.0	16.0		
Power consumption	Cooling	kW	0.077	0.092	0.092	0.130	0.130	0.161	0.209	0.256	
	Heating		0.044	0.059	0.059	0.097	0.097	0.126	0.176	0.223	
Casing		Galvanised steel plate									
Airflow rate (H/L)	ℓ/s	116/83	150/108	150/108	200/150	200/150	275/216	433/350	550/416		
	m ³ /min	7/5	9/6.5	9/6.5	12/9	12/9	16.5/13	26/21	33/25		
Sound level (H/L)	240 V	dB(A)		34/29	36/30	36/30	37/32	37/32	39/34	41/36	46/40
Dimensions (H×W×D)	mm	305×775×600	305×775×600	305×775×600	305×990×600	305×990×600	305×1,175×600	305×1,665×600	305×1,665×600		
Machine weight	kg	26	26	26	31	32	35	47	48		
Piping connections	Liquid (Flare)	mm	φ 6.4	φ 6.4	φ 6.4	φ 6.4	φ 6.4	φ 9.5	φ 9.5	φ 9.5	
	Gas (Flare)		φ 12.7	φ 12.7	φ 12.7	φ 12.7	φ 12.7	φ 15.9	φ 15.9	φ 15.9	
	Drain		VP25 (External Dia, 32/Internal Dia, 25)								
Panel (Option)	Model	BYBC32G-W1			BYBC50G-W1		BYBC63G-W1	BYBC125G-W1			
	Colour	White (10Y9/0.5)									
	Dimensions(H×W×D)	mm	53×1,030×680	53×1,030×680	53×1,030×680	53×1,245×680	53×1,245×680	53×1,430×680	53×1,920×680	53×1,920×680	
	Weight	kg	8.0	8.0	8.0	8.5	8.5	9.5	12.0	12.0	

Ceiling Mounted Cassette Corner Type

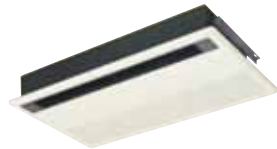

MODEL		FXKQ25MAVE	FXKQ32MAVE	FXKQ40MAVE	FXKQ63MAVE		
Power supply		1-phase, 220-240 V/220 V, 50/60 Hz					
Cooling capacity	kcal/h(*1)	2,500	3,200	4,000	6,300		
	Btu/h(*1)	9,900	12,600	16,000	24,900		
	kW	(*1)	2.9	3.7	4.7	7.3	
(*2)		2.8	3.6	4.5	7.1		
Heating capacity	kcal/h	2,800	3,400	4,300	6,900		
	Btu/h	10,900	13,600	17,100	27,300		
	kW	3.2	4.0	5.0	8.0		
Power consumption	Cooling	kW	0.066	0.066	0.076	0.105	
	Heating		0.046	0.046	0.056	0.085	
Casing		Galvanised steel plate					
Airflow rate (H/L)	ℓ/s	183/150	183/150	216/166	300/250		
	m ³ /min	11/9	11/9	13/10	18/15		
Sound level (H/L)	240 V	dB(A)		40/35	40/35	42/36	44/39
Dimensions (H×W×D)	mm	215×1,110×710	215×1,110×710	215×1,110×710	215×1,310×710		
Machine weight	kg	31	31	31	34		
Piping connections	Liquid (Flare)	mm	φ 6.4	φ 6.4	φ 6.4	φ 9.5	
	Gas (Flare)		φ 12.7	φ 12.7	φ 12.7	φ 15.9	
	Drain		VP25 (External Dia, 32/Internal Dia, 25)				
Panel (Option)	Model	BYK45FJW1			BYK71FJW1		
	Colour	White (10Y9/0.5)					
	Dimensions(H×W×D)	mm	70×1,240×800	70×1,240×800	70×1,240×800	70×1,440×800	
	Weight	kg	8.5	8.5	8.5	9.5	

Note: Specifications are based on the following conditions;

•Cooling: (*1) Indoor temp.: 27°CDB, 19.5°CWB, Outdoor temp.: 35°CDB, Equivalent piping length: 7.5 m, Level difference: 0 m.

(*2) Indoor temp.: 27°CDB, 19°CWB, Outdoor temp.: 35°CDB, Equivalent piping length: 7.5 m, Level difference: 0 m.

•Heating: Indoor temp.: 20°CDB, Outdoor temp.: 7°CDB, 6°CWB, Equivalent piping length: 7.5 m, Level difference: 0 m.

•Capacity of indoor unit is only for reference. Actual capacity of indoor unit is based on the total capacity index. (See Engineering Data Book for details.)

•Sound level: (FXCQ-M) Anechoic chamber conversion value, measured at a point 1.5 m downward from the unit centre.

(FXKQ-MA) Anechoic chamber conversion value, measured at a point 1 m in front of the unit and 1 m downward.

During actual operation, these values are normally somewhat higher as a result of ambient conditions.

SPECIFICATIONS

● INDOOR UNITS ●

Slim Ceiling Mounted Duct Type (700 mm width type)

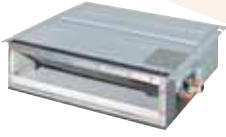

MODEL		FXDQ20PBVE	FXDQ25PBVE	FXDQ32PBVE	
Power supply		1-phase, 220-240 V/220 V, 50/60 Hz			
Cooling capacity	kcal/h (*1)	2,000	2,500	3,200	
	Btu/h (*1)	7,800	9,900	12,600	
	kW	(*1)	2.3	2.9	3.7
		(*2)	2.2	2.8	3.6
Heating capacity	kcal/h	2,200	2,800	3,400	
	Btu/h	8,500	10,900	13,600	
	kW	2.5	3.2	4.0	
Power consumption	Cooling	kW	0.086	0.086	
	Heating		0.067	0.067	
Casing		Galvanised steel plate			
Airflow rate (HH/H/L)	ℓ/s	133/120/106	133/120/106	133/120/106	
	m ³ /min	8.0/7.2/6.4	8.0/7.2/6.4	8.0/7.2/6.4	
External static pressure	Pa	30-10*1			
Sound level (HH/H/L)*2*3	dB(A)	33/31/29	33/31/29	33/31/29	
Sound power (HH)	dB(A)	51	51	51	
Dimensions (H×W×D)	mm	200×700×620	200×700×620	200×700×620	
Machine weight	kg	23	23	23	
Piping connections	Liquid (Flare)	mm	φ 6.4	φ 6.4	
	Gas (Flare)		φ 12.7	φ 12.7	
	Drain		VP20 (External Dia, 26/Internal Dia, 20)		

Slim Ceiling Mounted Duct Type (900/1,100 mm width type)



MODEL		FXDQ40NBVE	FXDQ50NBVE	FXDQ63NBVE	
Power supply		1-phase, 220-240 V/220 V, 50/60 Hz			
Cooling capacity	kcal/h (*1)	4,000	5,000	6,300	
	Btu/h (*1)	16,000	19,800	24,900	
	kW	(*1)	4.7	5.8	7.3
		(*2)	4.5	5.6	7.1
Heating capacity	kcal/h	4,300	5,400	6,900	
	Btu/h	17,100	21,500	27,300	
	kW	5.0	6.3	8.0	
Power consumption	Cooling	kW	0.160	0.165	
	Heating		0.147	0.152	
Casing		Galvanised steel plate			
Airflow rate (HH/H/L)	ℓ/s	175/158/141	208/183/166	275/241/216	
	m ³ /min	10.5/9.5/8.5	12.5/11.0/10.0	16.5/14.5/13.0	
External static pressure	Pa	44-15*1			
Sound level (HH/H/L)*2*3	dB(A)	34/32/30	35/33/31	36/34/32	
Sound power (HH)	dB(A)	52	53	54	
Dimensions (H×W×D)	mm	200×900×620	200×900×620	200×1,100×620	
Machine weight	kg	27	28	31	
Piping connections	Liquid (Flare)	mm	φ 6.4	φ 6.4	
	Gas (Flare)		φ 12.7	φ 12.7	
	Drain		VP20 (External Dia, 26/Internal Dia, 20)		

Note: Specifications are based on the following conditions:

- Cooling: (*1) Indoor temp.: 27°CDB, 19.5°CWB, Outdoor temp.: 35°CDB, Equivalent piping length: 7.5 m, Level difference: 0 m.
(*2) Indoor temp.: 27°CDB, 19°CWB, Outdoor temp.: 35°CDB, Equivalent piping length: 7.5 m, Level difference: 0 m.

- Heating: Indoor temp.: 20°CDB, Outdoor temp.: 7°CDB, 6°CWB, Equivalent piping length: 7.5 m, Level difference: 0 m.

- Capacity of indoor unit is only for reference. Actual capacity of indoor unit is based on the total capacity index. (See Engineering Data Book for details.)

- Sound level: Anechoic chamber conversion value, measured at a point 1.5 m downward from the unit centre. During actual operation, these values are normally somewhat higher as a result of ambient conditions.

- *1: External static pressure is changeable to set by the remote controller. This pressure means "High static pressure - Standard". (Factory setting is 10 Pa for FXDQ-PB models and 15 Pa for FXDQ-NB models.)

- *2: The values of operation sound level represent those for rear-suction operation. Sound level values for bottom-suction operation can be obtained by adding 5 dB(A).

- *3: Values are based on the following conditions: FXDQ-PB: external static pressure of 10 Pa; FXDQ-NB: external static pressure of 15 Pa.

● INDOOR UNITS ●

Ceiling Mounted Built-in Type



MODEL		FXSYQ20MVE	FXSYQ25MVE	FXSYQ32MVE	FXSYQ40MVE	FXSYQ50MVE	FXSYQ63MVE	FXSYQ80MVE	FXSYQ100MVE	FXSYQ125MVE	
Power supply		1-phase, 220-240 V, 50 Hz									
Cooling capacity	kcal/h (*1)	2,000	2,500	3,200	4,000	5,000	6,300	8,000	10,000	12,500	
	Btu/h (*1)	7,900	9,900	12,600	16,000	19,800	24,900	31,700	39,600	49,500	
	kW	(*1)	2.3	2.9	3.7	4.7	5.8	7.3	9.3	11.6	14.5
		(*2)	2.2	2.8	3.6	4.5	5.6	7.1	9.0	11.2	14.0
Heating capacity	kcal/h	2,200	2,800	3,400	4,300	5,400	6,900	8,600	10,800	13,800	
	Btu/h	8,500	10,900	13,600	17,100	21,500	27,300	34,100	42,700	54,600	
	kW	2.5	3.2	4.0	5.0	6.3	8.0	10.0	12.5	16.0	
Power consumption	Cooling	kW	0.089	0.089	0.096	0.106	0.145	0.178	0.304	0.309	0.366
	Heating		0.089	0.089	0.096	0.106	0.145	0.178	0.304	0.309	0.366
Casing		Galvanised steel plate									
Airflow rate (H/L)	ℓ/s	150/112	150/112	158/112	191/143	250/190	350/235	450/355	466/370	633/457	
	m ³ /min	9/6.72	9/6.72	9.5/6.72	11.5/8.58	15/11.4	21/14.1	27/21.3	28/22.2	38/27.42	
External static pressure	Pa	98-65-33*1	98-65-33*1	88-57-27*1	96-65-57*1	86-58-43*1	115-84-52*1	140-122-61*1	138-118-53*1	98-58*2	
Sound level (H/L)	230 V	dB(A)	41/33.5	41/33.5	41/33.5	41/34.5	43/37	45/38.5	48/43	48/43	49/41.5
Sound power (H/L)	230 V	dB(A)	58/50.5	58/50.5	58/50.5	58/51.5	60/54	62/55.5	65.5/60	65.5/60	66/59
Dimensions (H×W×D)	mm	300×550×800	300×550×800	300×550×800	300×700×800	300×700×800	300×1,000×800	300×1,400×800	300×1,400×800	300×1,400×800	
Machine weight	kg	30	30	30	34	35	44	57	57	57	
Piping connections	Liquid (Flare)	mm	φ 6.4	φ 6.4	φ 6.4	φ 6.4	φ 6.4	φ 9.5	φ 9.5	φ 9.5	φ 9.5
	Gas (Flare)		φ 12.7	φ 12.7	φ 12.7	φ 12.7	φ 12.7	φ 15.9	φ 15.9	φ 15.9	φ 15.9
	Drain		VP25 (External Dia, 32/Internal Dia, 25)								
Panel (Option)	Model		BYBS32DJW1	BYBS32DJW1	BYBS32DJW1	BYBS45DJW1	BYBS45DJW1	BYBS71DJW1	BYBS125DJW1	BYBS125DJW1	BYBS125DJW1
	Colour	White (10Y9/0.5)									
	Dimensions (H×W×D)	mm	55×650×500	55×650×500	55×650×500	55×800×500	55×800×500	55×1,100×500	55×1,500×500	55×1,500×500	55×1,500×500
	Weight	kg	3.0	3.0	3.0	3.5	3.5	4.5	6.5	6.5	6.5

Ceiling Concealed (Duct) Type



MODEL		FXDYQ80MAV1	FXDYQ100MAV1	FXDYQ125MAV1	FXDYQ145MAV1	
Power supply		1-phase, 220-240 V, 50 Hz				
Cooling capacity	kcal/h (*1)	8,000	10,000	12,500	14,500	
	Btu/h (*1)	31,700	39,600	49,500	57,600	
	kW	(*1)	9.3	11.6	14.5	16.9
		(*2)	8.8	11.2	13.9	16.0
Heating capacity	kcal/h	8,480	10,800	13,800	15,800	
	Btu/h	33,800	42,700	54,600	62,800	
	kW	9.9	12.5	16.0	18.4	
Power consumption	Cooling	kW	0.415	0.700	0.780	0.880
	Heating		0.415	0.700	0.780	0.880
Casing		Galvanised steel plate				
Airflow rate (H)	ℓ/s	510	778	852	957	
	m ³ /min	30.6	46.7	51.1	57.4	
External static pressure (H)	Pa	120 *3	120 *3	120 *3	120 *3	
Sound level (H)	240 V	dB(A)	45	46	48	51
Dimensions (H×W×D)	mm	360×1168×869	360×1478×899	360×1478×899	360×1478×899	
Machine weight	kg	50	60	65	66	
Piping connections	Liquid (Flare)	mm	φ 9.5	φ 9.5	φ 9.5	φ 9.5
	Gas (Flare)		φ 15.9	φ 15.9	φ 15.9	φ 15.9
	Drain		VP25 (External Dia, 32/Internal Dia, 25)			

Note: Specifications are based on the following conditions;

- Cooling: (*1) Indoor temp.: 27°CDB, 19.5°CWB, Outdoor temp.: 35°CDB, Equivalent piping length: 7.5 m, Level difference: 0 m.
(*2) Indoor temp.: 27°CDB, 19°CWB, Outdoor temp.: 35°CDB, Equivalent piping length: 7.5 m, Level difference: 0 m.

- Heating: Indoor temp.: 20°CDB, Outdoor temp.: 7°CDB, 6°CWB, Equivalent piping length: 7.5 m, Level difference: 0 m.

- Capacity of indoor unit is only for reference. Actual capacity of indoor unit is based on the total capacity index. (See Engineering Data Book for details.)

- Sound level: (FXSYQ) Anechoic chamber conversion value, based on Australian Standard 1217.6-1985. Measurement is based on bottom-return air entry.

(FXDYQ) Anechoic chamber conversion value, measured at a point 1.5 m downward from the unit centre.

During actual operation, these values are normally somewhat higher as a result of ambient conditions.

- For FXDYQ models, an air filter is not a standard accessory. A suitable locally obtained filter must be installed in the return air duct.

- *1: External static pressure is changeable to change over the connectors inside electrical box, this pressure means

"High static pressure-Standard-Low static pressure".

- *2: External static pressure is changeable to change over the connectors inside electrical box, this pressure means "High static pressure-Standard".

- *3: External static pressure is changeable to change over the connectors inside electrical box (High static pressure-Standard static pressure).

The data above is for high static pressure setting.

SPECIFICATIONS

● INDOOR UNITS ●

Ceiling Mounted Duct Type



MODEL		FXMQ20PVE	FXMQ25PVE	FXMQ32PVE	FXMQ40PVE	FXMQ50PVE	
Power supply		1-phase, 220-240 V/220 V, 50/60 Hz					
Cooling capacity	kcal/h (*1)	2,000	2,500	3,200	4,000	5,000	
	Btu/h (*1)	7,800	9,900	12,600	16,000	19,800	
	kW	(*1)	2.3	2.9	3.7	4.7	5.8
		(*2)	2.2	2.8	3.6	4.5	5.6
Heating capacity	kcal/h	2,200	2,800	3,400	4,300	5,400	
	Btu/h	8,500	10,900	13,600	17,100	21,500	
	kW	2.5	3.2	4.0	5.0	6.3	
Power consumption	Cooling	kW	0.081	0.081	0.085	0.194	0.215
	Heating		0.069	0.069	0.073	0.182	0.203
Casing		Galvanised steel plate					
Airflow rate (HH/H/L)	ℓ/s	150/125/108	150/125/108	158/133/116	267/216/183	300/275/250	
	m ³ /min	9/7.5/6.5	9/7.5/6.5	9.5/8/7	16/13/11	18/16.5/15	
External static pressure	Pa	30-100 *1	30-100 *1	30-100 *1	30-160 *1	50-200 *1	
Sound level (HH/H/L)	dB(A)	33/31/29	33/31/29	34/32/30	39/37/35	41/39/37	
Sound power (H)	dB(A)	51	51	52	57	59	
Dimensions (H×W×D)	mm	300×550×700	300×550×700	300×550×700	300×700×700	300×1,000×700	
Machine weight	kg	25	25	25	28	36	
Piping connections	Liquid (Flare)	mm	φ 6.4	φ 6.4	φ 6.4	φ 6.4	φ 6.4
	Gas (Flare)		φ 12.7	φ 12.7	φ 12.7	φ 12.7	φ 12.7
	Drain		VP25 (External Dia, 32/Internal Dia, 25)				

MODEL		FXMQ63PVE	FXMQ80PVE	FXMQ100PVE	FXMQ125PVE	FXMQ140PVE	
Power supply		1-phase, 220-240 V/220 V, 50/60 Hz					
Cooling capacity	kcal/h (*1)	6,300	8,000	10,000	12,500	14,300	
	Btu/h (*1)	24,900	31,700	39,600	49,500	57,000	
	kW	(*1)	7.3	9.3	11.6	14.5	16.7
		(*2)	7.1	9.0	11.2	14.0	16.0
Heating capacity	kcal/h	6,900	8,600	10,800	13,800	15,500	
	Btu/h	27,300	34,100	42,700	54,600	61,400	
	kW	8.0	10.0	12.5	16.0	18.0	
Power consumption	Cooling	kW	0.230	0.298	0.376	0.461	0.461
	Heating		0.218	0.286	0.364	0.449	0.449
Casing		Galvanised steel plate					
Airflow rate (HH/H/L)	ℓ/s	325/292/267	417/375/333	533/450/383	650/550/466	766/649/533	
	m ³ /min	19.5/17.5/16	25/22.5/20	32/27/23	39/33/28	46/39/32	
External static pressure	Pa	50-200 *1	50-200 *1	50-200 *1	50-200 *1	50-140 *1	
Sound level (HH/H/L)	dB(A)	42/40/38	43/41/39	43/41/39	44/42/40	46/45/43	
Sound power (H)	dB(A)	60	61	61	62	64	
Dimensions (H×W×D)	mm	300×1,000×700	300×1,000×700	300×1,400×700	300×1,400×700	300×1,400×700	
Machine weight	kg	36	36	46	46	47	
Piping connections	Liquid (Flare)	mm	φ 9.5	φ 9.5	φ 9.5	φ 9.5	φ 9.5
	Gas (Flare)		φ 15.9	φ 15.9	φ 15.9	φ 15.9	φ 15.9
	Drain		VP25 (External Dia, 32/Internal Dia, 25)				

Note: Specifications are based on the following conditions;

- Cooling: (*1) Indoor temp.: 27°CDB, 19.5°CWB, Outdoor temp.: 35°CDB, Equivalent piping length: 7.5 m, Level difference: 0 m.
- (*2) Indoor temp.: 27°CDB, 19°CWB, Outdoor temp.: 35°CDB, Equivalent piping length: 7.5 m, Level difference: 0 m.

- Heating: Indoor temp.: 20°CDB, Outdoor temp.: 7°CDB, 6°CWB, Equivalent piping length: 7.5 m, Level difference: 0 m.

- Capacity of indoor unit is only for reference. Actual capacity of indoor unit is based on the total capacity index.

(See Engineering Data Book for details.)

- Sound level: Anechoic chamber conversion value, measured at a point 1.5 m downward from the unit centre.

During actual operation, these values are normally somewhat higher as a result of ambient conditions.

- *1: External static pressure can be modified using a remote controller that offers seven (FXMQ20-32P), thirteen (FXMQ40P), fourteen (FXMQ50-125P) or ten (FXMQ140P) levels of control. These values indicate the lowest and highest possible static pressures. The standard static pressure is 50 Pa for FXMQ20-32P and 100 Pa for FXMQ40-140P.

● INDOOR UNITS ●

Ceiling Suspended Type



MODEL		FXHQ32MAVE	FXHQ63MAVE	FXHQ100MAVE	
Power supply		1-phase, 220-240 V/220 V, 50/60 Hz			
Cooling capacity	kcal/h (*1)	3,200	6,300	10,000	
	Btu/h (*1)	12,600	24,900	39,600	
	kW	(*1)	3.7	7.3	11.6
		(*2)	3.6	7.1	11.2
Heating capacity	kcal/h	3,400	6,900	10,800	
	Btu/h	13,600	27,300	42,700	
	kW	4.0	8.0	12.5	
Power consumption	Cooling	0.111	0.115	0.135	
	Heating				
Casing		White (10Y9/0.5)			
Airflow rate (H/L)	ℓ/s	200/166	291/233	416/325	
	m ³ /min	12/10	17.5/14	25/19.5	
Sound level (H/L)	dB(A)	36/31	39/34	45/37	
Dimensions (H×W×D)	mm	195×960×680	195×1,160×680	195×1,400×680	
Machine weight	kg	24	28	33	
Piping connections	Liquid (Flare)	φ 6.4	φ 9.5	φ 9.5	
	Gas (Flare)	φ 12.7	φ 15.9	φ 15.9	
	Drain	VP20 (External Dia, 26/Internal Dia, 20)			

Wall Mounted Type



MODEL		FXAQ20PVE	FXAQ25PVE	FXAQ32PVE	FXAQ40PVE	FXAQ50PVE	FXAQ63PVE	
Power supply		1-phase, 220-240/220V, 50/60Hz						
Cooling capacity	kcal/h (*1)	2,000	2,500	3,200	4,000	5,000	6,300	
	Btu/h (*1)	7,800	9,900	12,600	16,000	19,800	24,900	
	kW	(*1)	2.3	2.9	3.7	4.7	5.8	7.3
		(*2)	2.2	2.8	3.6	4.5	5.6	7.1
Heating capacity	kcal/h	2,200	2,800	3,400	4,300	5,400	6,900	
	Btu/h	8,500	10,900	13,600	17,100	21,500	27,300	
	kW	2.5	3.2	4.0	5.0	6.3	8.0	
Power consumption	Cooling	0.019	0.028	0.030	0.020	0.033	0.050	
	Heating							
Casing		White (3.0Y8.5/0.5)						
Airflow rate (H/L)	ℓ/s	125/75	133/83	142/91	200/150	250/200	316/233	
	m ³ /min	7.5/4.5	8/5	8.5/5.5	12/9	15/12	19/14	
Sound level (H/L)	dB(A)	35/31	36/31	38/31	39/34	42/37	47/41	
Dimensions (H×W×D)	mm	290×795×238	290×795×238	290×795×238	290×1,050×238	290×1,050×238	290×1,050×238	
Machine weight	kg	11	11	11	14	14	14	
Piping connections	Liquid (Flare)	φ 6.4	φ 6.4	φ 6.4	φ 6.4	φ 6.4	φ 9.5	
	Gas (Flare)	φ 12.7	φ 12.7	φ 12.7	φ 12.7	φ 12.7	φ 15.9	
	Drain	VP13 (External Dia, 18/Internal Dia, 13)						

Note : Specifications are based on the following conditions;

- Cooling: Indoor temp.: (*1) 27°CDB, 19.5°CWB, Outdoor temp.: 35°CDB, Equivalent piping length: 7.5 m, Level difference: 0 m.
(*2) 27°CDB, 19°CWB, Outdoor temp.: 35°CDB, Equivalent piping length: 7.5 m, Level difference: 0 m.
- Heating: Indoor temp.: 20°CDB, Outdoor temp.: 7°CDB, 6°CWB, Equivalent piping length: 7.5 m, Level difference: 0 m.
- Capacity of indoor unit is only for reference. Actual capacity of indoor unit is based on the total capacity index. (See Engineering Data Book for details.)
- Sound level : Anechoic chamber conversion value, measured at a point 1 m in front of the unit and 1 m downward.
During actual operation, these values are normally somewhat higher as a result of ambient conditions.

SPECIFICATIONS

● INDOOR UNITS ●

Floor Standing Type/Concealed Floor Standing Type



FXLQ



FXNQ

MODEL		FXLQ20MAVE	FXLQ25MAVE	FXLQ32MAVE	FXLQ40MAVE	FXLQ50MAVE	FXLQ63MAVE
		FXNQ20MAVE	FXNQ25MAVE	FXNQ32MAVE	FXNQ40MAVE	FXNQ50MAVE	FXNQ63MAVE
Power supply		1-phase, 220-240 V/220 V, 50/60 Hz					
Cooling capacity	kcal/h(*1)	2,000	2,500	3,200	4,000	5,000	6,300
	Btu/h(*1)	7,800	9,900	12,600	16,000	19,800	24,900
	kW	(*1)	2.3	2.9	3.7	4.7	5.8
(*2)		2.2	2.8	3.6	4.5	5.6	7.1
Heating capacity	kcal/h	2,200	2,800	3,400	4,300	5,400	6,900
	Btu/h	8,500	10,900	13,600	17,100	21,500	27,300
	kW	2.5	3.2	4.0	5.0	6.3	8.0
Power consumption	Cooling	kW					
	Heating	kW					
Casing		FXLQ:Ivory white (5Y7.5/1) / FXNQ:Galvanised steel plate					
Airflow rate (H/L)	ℓ/s	116/100	116/100	133/100	183/141	233/183	266/200
	m³/min	7/6	7/6	8/6	11/8.5	14/11	16/12
Sound level (H/L)	240 V	dB(A)		37/34	37/34	37/34	40/35
Dimensions (H×W×D)	FXLQ	mm					
	FXNQ	mm					
Machine weight	FXLQ	kg					
	FXNQ	kg					
Piping connections	Liquid (Flare)	mm					
	Gas (Flare)	mm					
	Drain	φ 210.D.					

— Connection unit series indoor units

- * A type of BEV unit is necessary for each Connection unit series indoor unit. Refer to the Engineering Data Book for details.
- * If indoor units from the Connection unit series are connected within a single refrigerant system to indoor units from any other series, cooling/heating switchover will not be possible using the remote controller of the Connection unit series indoor units. However, if the remote controller of an indoor unit from the other series is set as a master remote controller, cooling/heating switchover will be possible.
- * If all indoor units are from the Connection unit series, an outdoor unit Cool/Heat selector will be needed to enable cooling/heating switchover.
- * Group control between Connection Unit series equipment within one system is possible. However, group control with the other VRV indoor units is not possible.

Ceiling Suspended Cassette Type



MODEL	Indoor unit		FXUQ71MAV1	FXUQ100MAV1	FXUQ125MAV1		
	Connection unit		BEVQ71MAVE	BEVQ100MAVE	BEVQ125MAVE		
Power supply			1-phase, 220-240 V, 50 Hz				
Cooling capacity	Kcal/h(*1)		7,100	10,000	12,500		
	Btu/h(*1)		28,300	39,600	49,500		
	kW	(*1)	8.3	11.6	14.5		
(*2)		8.0	11.2	14.0			
Heating capacity (Max.)	Kcal/h		7,700	10,800	12,000		
	Btu/h		30,700	42,700	47,800		
	kW		9.0	12.5	14.0		
Power consumption	Cooling	kW		0.189	0.298	0.298	
	Heating	kW		0.169	0.278	0.278	
Casing			White(10Y9/0.5)				
Indoor unit	Airflow rate (H/L)	ℓ/s	316/233	483/350	533/383		
		m³/min	19/14	29/21	32/23		
Indoor unit	Sound level (H/L)	230 V	dB(A)		40/35	43/38	44/39
Indoor unit	Sound power (H)	dB(A)		56	59	60	
Indoor unit	Dimensions (H×W×D)	mm		165×895×895	230×895×895	230×895×895	
Indoor unit	Machine weight	kg		25	31	31	
Piping connections	Liquid	mm					
	Gas	mm					
	Drain	mm					

Note: Specifications are based on the following conditions;

- Cooling: (*1) Indoor temp.: 27°CDB, 19.5°CWB, Outdoor temp.: 35°CDB, Equivalent piping length: 7.5 m, Level difference: 0 m.
(*2) Indoor temp.: 27°CDB, 19°CWB, Outdoor temp.: 35°CDB, Equivalent piping length: 7.5 m, Level difference: 0 m.
- Heating: Indoor temp.: 20°CDB, Outdoor temp.: 7°CDB, 6°CWB, Equivalent piping length: 7.5 m, Level difference: 0 m.
- Capacity of indoor unit is only for reference. Actual capacity of indoor unit is based on the total capacity index. (See Engineering Data Book for details.)
- Sound level: (FXLQ-MA, FXNQ-MA) Anechoic chamber conversion value, measured at a point 1 m in front of the unit and 1 m downward.
(FXUQ-MA) Anechoic chamber conversion value, measured at a point 1.5 m in front of the unit at a height of 1.5 m.
During actual operation, these values are normally somewhat higher as a result of ambient conditions.

● OUTDOOR UNITS ●

Heat Pump



MODEL			RXYMQ4PV4A	RXYMQ5PV4A	RXYMQ6PV4A
Power supply			1-phase, 230–240 V, 50 Hz		
Cooling capacity		Kcal/h	9,600	12,000	13,300
		Btu/h	38,200	47,800	52,900
		kW	11.2	14.0	15.5
Heating capacity		Kcal/h	10,800	13,800	15,500
		Btu/h	42,700	54,600	61,400
		kW	12.5	16.0	18.0
Power consumption	Cooling	kW	2.95	3.97	4.44
	Heating		3.27	4.09	4.82
Capacity control		%	24 to 100		
Casing colour			Ivory white (5Y7.5/1)		
Compressor	Type		Hermetically sealed scroll type		
	Motor output	kW	2.5	3.0	3.5
Airflow rate		ℓ/s	1,766		
		m ³ /min	106		
Dimensions (H x W x D)		mm	1,345 x 900 x 320		
Machine weight		kg	125		
Sound level (Cooling/Heating)		dB(A)	50/52	51/53	53/55
Sound power		dB(A)	68	69	71
Operation range	Cooling	°CDB	-5 to 46		
	Heating	°CWB	-20 to 15.5		
Refrigerant	Type		R-410A		
	Charge	kg	4.0		
Piping connections	Liquid	mm	ø9.5 (Flare)		
	Gas		ø15.9 (Flare)	ø19.1 (Brazing)	

Note: Specifications are based on the following conditions;

- Cooling: Indoor temp.: 27°CDB, 19.5°CWB, Outdoor temp.: 35°CDB, Equivalent piping length: 7.5 m, Level difference: 0 m.
- Heating: Indoor temp.: 20°CDB, Outdoor temp.: 7°CDB, 6°CWB, Equivalent piping length: 7.5 m, Level difference: 0 m.
- Sound level: Anechoic chamber conversion value, measured at a point 1 m in front of the unit at a height of 1.5 m. During actual operation, these values are normally somewhat higher as a result of ambient conditions.
- Refrigerant charge is required.

OPTION LIST

● INDOOR UNITS ●

Ceiling Mounted Cassette (Round Flow) Type

No.	Item	Type	FXFQ25P	FXFQ32P	FXFQ40P	FXFQ50P	FXFQ63P	FXFQ80P	FXFQ100P	FXFQ125P
1	Decoration panel		BYCP125K-W1							
2	Sealing member of air discharge outlet		KDBH55K160F							
3	Panel spacer		KDBP55H160FA							
4	Filter related	High efficiency filter unit 65%	KAFP556B80				KAFP556B160			
		High efficiency filter unit 90%	KAFP557B80				KAFP557B160			
		Replacement high efficiency filter 65%	KAFP552B80				KAFP552B160			
		Replacement high efficiency filter 90%	KAFP553B80				KAFP553B160			
		Filter chamber	KDDFP55B160							
		Long life replacement filter Non-woven type	KAFP551K160							
		Ultra long-life filter	KAFP55B160							
5	Fresh air intake kit	Chamber type Without T shape and fan	KDDP55B160							
		Chamber type With T shape without fan	KDDP55B160K							
		Direct installation type	KDDP55X160							
6	Branch duct chamber	KDJP55B80						KDJP55B160		
7	Chamber connection kit	KKSJ55KA160								
8	Insulation kit for high humidity	KDTP55K80						KDTP55K160		

Ceiling Mounted Cassette (Compact Multi Flow) Type

No.	Item	Type	FXZQ20M	FXZQ25M	FXZQ32M	FXZQ40M	FXZQ50M
1	Decoration panel		BYFQ60B8W1				
2	Sealing member of air discharge outlet		KDBH44BA60				
3	Panel spacer		KDBQ44BA60A				
4	Replacement long-life filter		KAFQ441BA60				
5	Fresh air intake kit	Direct installation type	KDDQ44XA60				

Ceiling Mounted Cassette (Double Flow) Type

No.	Item	Type	FXCQ20M FXCQ25M FXCQ32M	FXCQ40M	FXCQ50M	FXCQ63M	FXCQ80M	FXCQ125M
1	Decoration Panel		BYBC32G-W1	BYBC50G-W1	BYBC63G-W1	BYBC125G-W1		
2	Filter related	High efficiency filter 65% *1	KAFJ532G36	KAFJ532G56	KAFJ532G80	KAFJ532G160		
		High efficiency filter 90% *1	KAFJ533G36	KAFJ533G56	KAFJ533G80	KAFJ533G160		
		Filter chamber bottom suction	KDDFJ53G36	KDDFJ53G56	KDDFJ53G80	KDDFJ53G160		
		Long life replacement filter	KAFJ531G36	KAFJ531G56	KAFJ531G80	KAFJ531G160		

Note: *1 Filter chamber is required if installing high efficiency filter.

Ceiling Mounted Cassette Corner Type

No.	Item	Type	FXKQ25MA	FXKQ32MA	FXKQ40MA	FXKQ63MA
1	Panel related	Decoration panel	BYK45FJW1			BYK71FJW1
		Panel spacer	KPBJ52F56W			KPBJ52F80W
2	Air inlet and air discharge outlet related	Long life replacement filter	KAFJ521F56			KAFJ521F80
		Air discharge grille	K-HV7AW			K-HV9AW
		Air discharge blind panel	KDBJ52F56W			KDBJ52F80W
		Flexible duct (with shutter)	KFDJ52FA56			KFDJ52FA80

Slim Ceiling Mounted Duct Type (700 mm width type)

No.	Item	Type	FXDQ20PB	FXDQ25PB	FXDQ32PB
1	Insulation kit for high humidity		KDT25N32		

Slim Ceiling Mounted Duct Type (900/1,100 mm width type)

No.	Item	Type	FXDQ40NB	FXDQ50NB	FXDQ63NB
1	Insulation kit for high humidity		KDT25N50		KDT25N63

● INDOOR UNITS ●

Ceiling Mounted Built-in Type

No.	Item	Type	FXSYQ20M FXSYQ25M FXSYQ32M	FXSYQ40M FXSYQ50M	FXSYQ63M	FXSYQ80M FXSYQ100M FXSYQ125M
1	Panel related	Decoration panel	BYBS32DJW1	BYBS45DJW1	BYBS71DJW1	BYBS125DJW1
		Access panel	KTBJ25K36W	KTB25KA56W	KTB25KA80W	KTB25KA160W
2	Filter related	High efficiency filter 65% *1	KAFJ252L36	KAF252LA56	KAF252LA80	KAF252LA160
		High efficiency filter 90% *1	KAFJ253L36	KAF253LA56	KAF253LA80	KAF253LA160
		Long life replacement filter	KAFJ251K36	KAFJ251K56	KAFJ251K80	KAFJ251K160
		Filter chamber for bottom suction	KAJ25L36D	KAJ25LA56D	KAJ25LA80D	KAJ25LA160D
3	Air inlet related	Air suction canvas	KSA-25K36	KSA-25KA56	KSA-25KA80	KSA-25KA160
		Screening door	KBBJ25K36	KBBJ25KA56	KBBJ25KA80	KBBJ25KA160

Note: *1 If installing a high efficiency filter in the Ceiling Mounted Built-in type, a filter chamber for bottom suction is required.

Ceiling Concealed (Duct) Type

No.	Item	Type	FXDYQ80MA	FXDYQ100MA	FXDYQ125MA	FXDYQ145MA
1	Run/fault status PCB		KRP1B5X			

Ceiling Mounted Duct Type

No.	Item	Type	FXMQ20P FXMQ25P FXMQ32P	FXMQ40P	FXMQ50P FXMQ63P FXMQ80P	FXMQ100P FXMQ125P FXMQ140P	FXMQ200MA FXMQ250MA
1	Drain pump kit		—				KDU30L250VE
2	High efficiency filter	65%	KAF372AA36	KAF372AA56	KAF372AA80	KAF372AA160	KAFJ372L280
		90%	KAF373AA36	KAF373AA56	KAF373AA80	KAF373AA160	KAFJ373L280
3	Filter chamber		KDDF37AA36	KDDF37AA56	KDDF37AA80	KDDF37AA160	KDJ3705L280
4	Long life replacement filter		KAF371AA36	KAF371AA56	KAF371AA80	KAF371AA160	KAFJ371L280
5	Long life filter chamber kit		KAF375AA36	KAF375AA56	KAF375AA80	KAF375AA160	—
6	Service panel	White	KTBJ25K36W	KTB25KA56W	KTB25KA80W	KTB25KA160W	
		Fresh white	KTBJ25K36F	KTBJ25K56F	KTBJ25K80F	KTBJ25K160F	
		Brown	KTBJ25K36T	KTBJ25K56T	KTBJ25K80T	KTBJ25K160T	
7	Air discharge adaptor		KDAJ25K36A	KDAJ25K56A	KDAJ25K71A	KDAJ25K140A	

Ceiling Suspended Type

No.	Item	Type	FXHQ32MA	FXHQ63MA	FXHQ100MA
1	Drain pump kit		KDU50N60VE	KDU50N125VE	
2	Replacement long-life filter (Resin net)		KAF501DA56	KAF501DA80	KAF501DA112
3	L-type piping kit (for upward direction)		KHFP5MA63	KHFP5MA160	

Wall Mounted Type

No.	Item	Type	FXAQ20P	FXAQ25P	FXAQ32P	FXAQ40P	FXAQ50P	FXAQ63P
1	Drain pump kit		K-KDU572EVE					

Floor Standing Type

No.	Item	Type	FXLQ20MA	FXLQ25MA	FXLQ32MA	FXLQ40MA	FXLQ50MA	FXLQ63MA
1	Long life replacement filter		KAFJ361K28		KAFJ361K45		KAFJ361K71	

OPTION LIST

● INDOOR UNITS ●

Concealed Floor Standing Type

No.	Item	Type	FXNQ20MA	FXNQ25MA	FXNQ32MA	FXNQ40MA	FXNQ50MA	FXNQ63MA	
1	Long life replacement filter		KAFJ361K28		KAFJ361K45		KAFJ361K71		

Ceiling Suspended Cassette Type

No.	Item	Type	FXUQ71MA	FXUQ100MA	FXUQ125MA
1	Replacement long-life filter		KAF495FA140		
2	Sealing member of air discharge outlet ^(*)		KDBH49FA80	KDBH49FA140	
3	Decoration panel for air discharge		KDBT49FA80	KDBT49FA140	
4	Vertical flap kit		KDGJ49FA80	KDGJ49FA140	
5	L-shape piping kit		KHFP49MA140		

Note: (*) This option is necessary for setting up 2-way (opposing directional) airflow when the air conditioner is installed.

● OUTDOOR UNITS ●

Heat Pump

No.	Item	Type	RXYMQ4P	RXYMQ5P	RXYMQ6P
1	Cool/Heat selector		KRC19-26A		
1-1	Fixing box		KJB111A		
2	REFNET header		KHRP26M22H (Max. 4 branch)		
			KHRP26M33H (Max. 8 branch)		
3	REFNET joint		KHRP26A22T		
4	Central drain plug		KKPJ5F180		
5	Fixture for preventing overturning		KPT-60B160		
6	Wire fixture for preventing overturning		K-KYZP15C		

● CONTROL SYSTEMS ●

Operation Control System Optional Accessories

No.	Item	Type	FXFQ-P	FXZQ-M	FXCQ-M	FXKQ-MA	FXDQ-PB FXDQ-NB	FXSYQ-M	FXDYQ-MA	FXMQ-P	FXHQ-MA	FXAQ-P	FXLQ-MA FXNQ-MA	FXUQ-MA
1	Remote controller	Wireless	BRC7F634F	BRC7E530W	BRC7C62	BRC4C61	BRC4C65	BRC4C62	BRC4C62	BRC4C65	BRC7EA63W	BRC7EA618	BRC4C62	BRC7CA528W
		Wired	BRC1C62											
2	Wired remote controller with weekly schedule timer		BRC1D61											
3	Simplified remote controller (Exposed type)		—				BRC2C51				—		BRC2C51	—
4	Remote controller for hotel use (Concealed type)		—				BRC3A61				—		BRC3A61	—
5	Adaptor for wiring		*KRP1C63	*KRP1BA57	*KRP1B61	KRP1B61	*KRP1B56	KRP1B61	KRP1B61	*KRP1C64	KRP1BA54	—	KRP1B61	—
6-1	Wiring adaptor for electrical appendices (1)		*KRP2A62	*KRP2A62	*KRP2A61	KRP2A61	*KRP2A53	KRP2A61	KRP2A61	*KRP2A61	*KRP2A62	*KRP2A61	KRP2A61	—
6-2	Wiring adaptor for electrical appendices (2)		*KRP4AA53	*KRP4AA53	*KRP4AA51	KRP4AA51	*KRP4A54	KRP4AA51	KRP4AA51	*KRP4AA51	*KRP4AA52	*KRP4AA51	KRP4AA51	*KRP4AA53
7	Remote sensor (for indoor temperature)		KRCS01-4B	KRCS01-1B						KRCS01-4B	KRCS01-1B			
8	Installation box for adaptor PCB [☆]		Note 2.3 KRP1H98	Note 4.6 KRP1BA101	Note 2.3 KRP1B96	—	Note 4.6 KRP1BA101	Note 5 KRP4A91	—	Note 2.3 KRP4A96	Note3 KRP1CA93	Note 2.3 KRP4AA93	—	KRP1BA97
9	External control adaptor for outdoor unit		*DTA104A62	*DTA104A61	DTA104A61	*DTA104A53	DTA104A61		*DTA104A61	*DTA104A62	*DTA104A61	DTA104A61	—	
10	Adaptor for multi tenant		*DTA114A61	—						*DTA114A61	—	*DTA114A61	—	

Note: 1. Installation box ☆ is necessary for each adaptor marked ☆.
2. Up to 2 adaptors can be fixed for each installation box.

3. Only one installation box can be installed for each indoor unit.
4. Up to 2 installation boxes can be installed for each indoor unit.

5. Installation box ☆ is necessary for second adaptor.
6. Installation box ☆ is necessary for each adaptor.

● CONTROL SYSTEMS ●

System Configuration

No.	Item		Model No.	Function
1	Residential central remote controller		Note 3 DCS303A51	•Up to 16 groups of indoor units (128 units) can be easily controlled using the large LCD panel. ON/OFF, temperature settings and scheduling can be controlled individually for indoor units.
2	Central remote controller		Note 2 DCS302CA61	•Up to 64 groups of indoor units(128 units) can be connected, and ON/OFF, temperature setting and monitoring can be accomplished individually or simultaneously. Connectable up to 2 controllers in one system.
2-1	Electrical box with earth terminal (3 blocks)		KJB311AA	
3	Unified ON/OFF controller		Note 2 DCS301BA61	•Up to 16 groups of indoor units(128 units) can be turned, ON/OFF individually or simultaneously, and operation and malfunction can be displayed. Can be used in combination with up to 8 controllers.
3-1	Electrical box with earth terminal (2 blocks)		KJB212AA	
3-2	Noise filter (for electromagnetic interface use only)		KEK26-1A	
4	Schedule timer		Note 2 DST301BA61	•Programmed time weekly schedule can be controlled by unified control for up to 64 groups of indoor units (128 units). Can turn units ON/OFF twice per day.
5	Interface adaptor for SkyAir series	For SkyAir, FD(YM-FA, FDY-KA, FDYB-KA, FVY(P)J-A, FXUQ-MA	★ DTA102A52	•Adaptors required to connect products other than those of the VRV System to the high-speed DIII-NET communication system adopted for the VRV System. * To use any of the above optional controllers, an appropriate adaptor must be installed on the product unit to be controlled.
		For SkyAir FFQ-B, FHQ-BV, FAQ100BV, FBQ-B	★DTA112BA51	
6	Central control adaptor kit	For UAT(Y)-K(A),FD-K	★ DTA107A55	
7	Wiring adaptor for other air-conditioner		★ DTA103A51	
8	DIII-NET Expander Adaptor		DTA109A51	•Up to 1024 units can be centrally controlled in 64 different groups. •Wiring restrictions (max. length: 1,000 m, total wiring length: 2,000 m, max. number of branches: 16) apply to each adaptor.
8-1	Mounting plate		KRP4A92	•Fixing plate for DTA109A51

Notes: 1. Installation box for ★ adaptor must be obtained locally.
2. For FXUQ-MAV1, an interface adaptor (DTA102A52) for the SkyAir series is necessary.
3. For residential use only. Cannot be used with other centralised control equipment.

Building Management System

No.	Item			Model No.	Function	
1	intelligent Touch Controller	Basic	Hardware	intelligent Touch Controller	DCS601C51	•Air-Conditioning management system that can be controlled by a compact all-in-one unit.
1-1		Option	Hardware	DIII-NET plus adaptor	DCS601A52	•Additional 64 groups (10 outdoor units) is possible.
1-2	Electrical box with earth terminal (4 blocks)			KJB411A	•Wall embedded switch box.	
2	intelligent Touch Manager	Basic	Hardware	intelligent Touch Manager	DCM601A51	•Air-conditioning management system that can be controlled by touch screen.
2-1		Option	Hardware	iTM plus adaptor	DCM601A52	•Additional 64 groups (10 outdoor units) is possible. Max. 7 iTM plus adaptors can be connected to intelligent Touch Manager.
2-2				iTM integrator	DCM601A53	•Max. 5 intelligent Touch Managers can be integrated.
2-3			Software	iTM power proportional distribution	DCM002A51	•Power consumption of indoor units are calculated based on operation status of the indoor unit and outdoor unit power consumption measured by kWh metre.
2-4		iTM energy navigator		DCM008A51	•Building energy consumption is visualised. Wasted air-conditioning energy can be found out.	
2-5	Di unit			DEC101A51	•8 pairs based on a pair of On/Off input and abnormality input.	
2-6	Dio unit			DEC102A51	•4 pairs based on a pair of On/Off input and abnormality input.	
3	Communication line	*1 Interface for use in BACnet*		DMS502B51	•Interface unit to allow communications between VRV and BMS. Operation and monitoring of air-conditioning systems through BACnet* communication.	
3-1		Optional DIII board		DAM411B51	•Expansion kit, installed on DMS502B51, to provide 2 more DIII-NET communication ports. Not usable independently.	
3-2		Optional Di board		DAM412B51	•Expansion kit, installed on DMS502B51, to provide 16 more wattmeter pulse input points. Not usable independently.	
4		*2 Interface for use in LONWORKS*		DMS504B51	•Interface unit to allow communications between VRV and BMS. Operation and monitoring of air-conditioning systems through LONWORKS* communication.	
5	Contact/analogue signal	Unification adaptor for computerised control		★ DCS302A52	•Interface between the central monitoring board and central control units.	

Notes: *1. BACnet* is a registered trademark of American Society of Heating, Refrigerating and Air-Conditioning Engineers (ASHRAE).
2. LONWORKS is a trademark of Echelon Corporation registered in the United States and other countries.
*3. Installation box for ★ adaptor must be obtained locally.

Warning



- Daikin products are manufactured for export to numerous countries throughout the world. Prior to purchase, please confirm with your local authorised importer, distributor and/or retailer whether this product conforms to the applicable standards, and is suitable for use, in the region where the product will be used. This statement does not purport to exclude, restrict or modify the application of any local legislation.
 - Ask a qualified installer or contractor to install this product. Do not try to install the product yourself. Improper installation can result in water or refrigerant leakage, electrical shock, fire or explosion and may have resultant impacts on warranty.
 - Use only those parts and accessories supplied or specified by Daikin. Ask a qualified installer or contractor to install those parts and accessories. Use of unauthorised parts and accessories or improper installation of parts and accessories can result in water or refrigerant leakage, electrical shock, fire or explosion.
 - Read the User's Manual carefully before using this product. The User's Manual provides important safety instructions and warnings. Be sure to follow these instructions and warnings.
- If you have any enquiries, please contact your local importer, distributor and/or retailer.

Cautions on product corrosion

1. Air conditioners should not be installed in areas where corrosive gases, such as acid gas or alkaline gas, are produced.
2. If the outdoor unit is to be installed close to the sea shore, direct exposure to the sea breeze should be avoided. If you need to install the outdoor unit close to the sea shore, contact your local distributor.



JMI-0107

Organization:
DAIKIN INDUSTRIES, LTD.
AIR CONDITIONING MANUFACTURING
DIVISION

Scope of Registration:
THE DESIGN/DEVELOPMENT AND
MANUFACTURE OF COMMERCIAL AIR
CONDITIONING, HEATING, COOLING,
REFRIGERATING EQUIPMENT, HEATING
EQUIPMENT, RESIDENTIAL AIR
CONDITIONING EQUIPMENT, HEAT
RECLAIM VENTILATION, AIR CLEANING
EQUIPMENT, COMPRESSORS AND VALVES.



JQA-1452

Organization:
DAIKIN INDUSTRIES
(THAILAND) LTD.

Scope of Registration:
THE DESIGN/DEVELOPMENT
AND MANUFACTURE OF AIR
CONDITIONERS AND THE
COMPONENTS INCLUDING
COMPRESSORS USED FOR
THEM



Quality
ISO 9001

Daikin Australia
Pty Limited (ISO9001)
QEC23256 May 31, 2006
Sydney, Brisbane, Adelaide,
Melbourne, Newcastle,
Townsville, Perth, Auckland



EC99J2044

All of the Daikin
Group's business
facilities and
subsidiaries in Japan
are certified under the
ISO 14001
international standard
for environment
management.



Environment
ISO 14001

Daikin Australia
Pty Limited (ISO14001)
CEM20437 October 27, 2006
Sydney, Brisbane, Melbourne,
Adelaide

Dealer

DAIKIN INDUSTRIES, LTD.

Head Office:
Umeda Center Bldg., 2-4-12, Nakazaki-Nishi,
Kita-ku, Osaka, 530-8323 Japan

Tokyo Office:
JR Shinagawa East Bldg., 2-18-1, Konan,
Minato-ku, Tokyo, 108-0075 Japan

http://www.daikin.com/global_ac/

© All rights reserved
Printed in Australia 09/12 Y.K.